

Accelerometer type 8315 data sheet

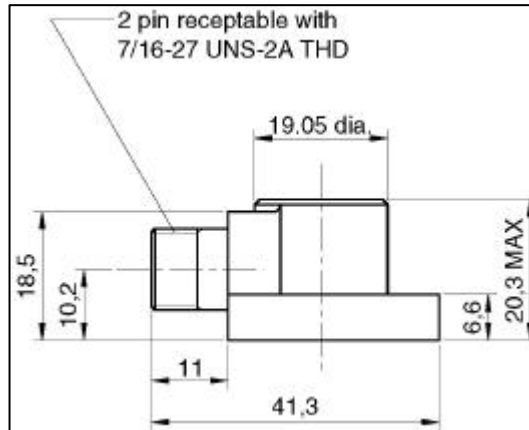

1. Application

Charge type accelerometer.

2. Usage

The 8315 Accelerometer is designed for permanent vibration monitoring installations in a wide variety of applications. It is intended as a general-purpose monitoring transducer. It may be used in areas where there is radiation.

The accelerometer utilises a "shear" construction that significantly reduces transient temperature and base strain outputs, while maintaining a high resonance when mounted and a high operating temperature.

3. Technical Data

Dynamic:

Sensitivity (Axial): 10 pC/ms⁻², ±5%
 Measuring range (peak): ±20,000 ms⁻²
 Resonant frequency, typical: 28 kHz
 Frequency response: ±10%: 1 Hz to 10 kHz

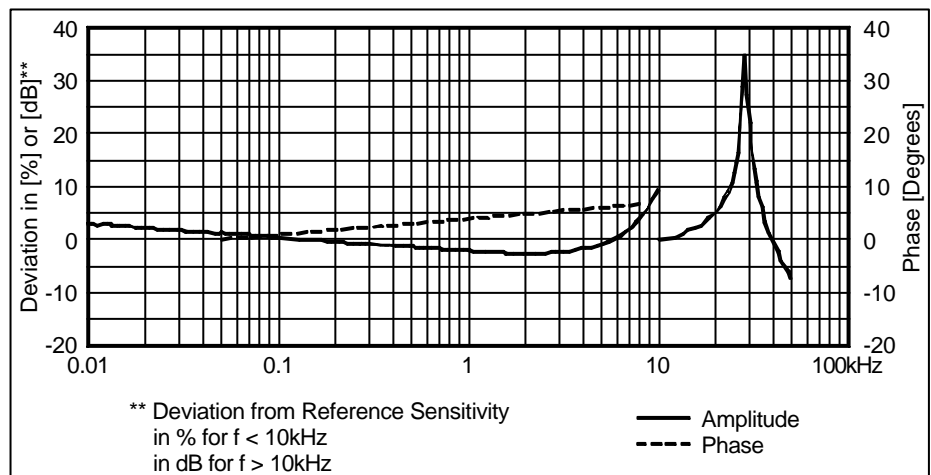

Transverse response:

Resonance frequency, typical:..... 9.4 kHz
 Maximum sensitivity:.....<4%
 Amplitude linearity: >1% increase per 2,000 ms⁻²
 Temperature response, typical: ±10% from -53°C to +125°C

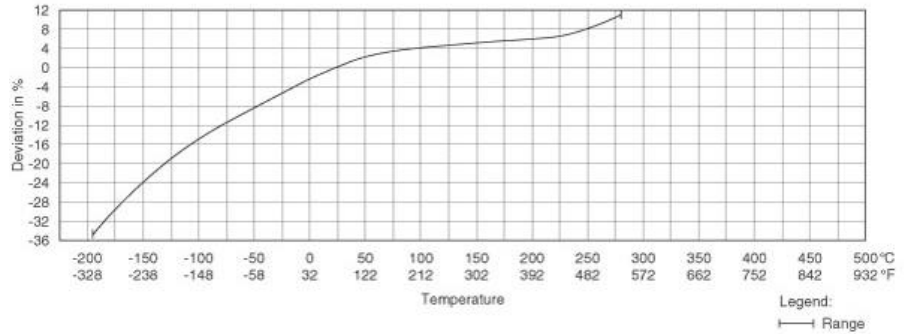

Typical temperature response

Electrical:

Resistance, typical

Between signal pins (+25°C):>10 GO
 Between signal pins (max temp.):>50 MO
 Each signal pin to case (+25°C):>10 GO
 Each signal pin to case (max temp.):>50 MO

Capacitance, typical

Between signal pins, excl cable: 12,2 nF
 Either signal lead to case: <30 pF
 Unbalance between pins: <2 pF

Base strain sensitivity, typical in base plain at 250µε: 0.008 ms⁻²/µε

Temperature transient sensitivity, typical:

with 3 Hz high pass filter:0.05 ms⁻²/°C

Isolation (500 VDC at -50°C to 125°C):>100 MO

Grounding:Signal wires isolated from case

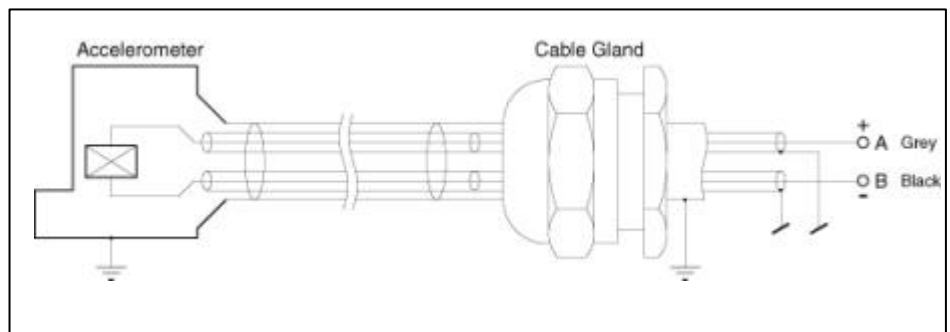

Electrical layout

Environmental:

Maximum acceleration limits (peak)

Shock limit:..... 10,000 ms⁻²

Sinusoidal vibration limit: 5,000 ms⁻²

Temperature range (accelerometer only): -196°C to +260°C

Electromagnetic sensitivity, 50 Hz, 38 mT: typical: 25 ms⁻²/T

Enclosure protection with cable integrated: IP 67

Accelerometer hermetically sealed.

Physical:

Weight (cable not included): 62 g
 Case material: Stainless steel, 316L
 Polarity: Positive on left pin or gray signal wire
 Acceleration directed from base into body
 Piezoelectric element construction: Shear, Piezite P-8®
 Footprint: ARINC
 Mounting: 3 x M4
 Torque: 2.9 Nm

ARINC Footprint:

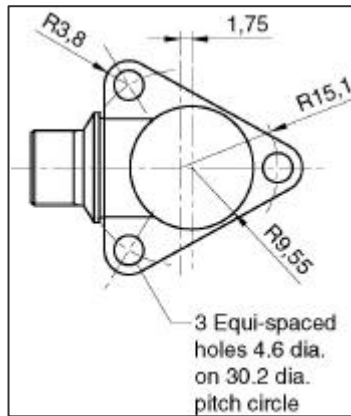

Mounting space:

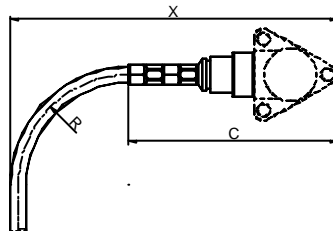

Minimum bending radius (R): 39 mm
 Accelerometer height w. integrated cable(C): 70 mm
 The mounting space can be calculated as $X_{min} = C + R$

The figure shows the dimension for the Type 8315 with connected cable.

Connection to charge preamplifier:

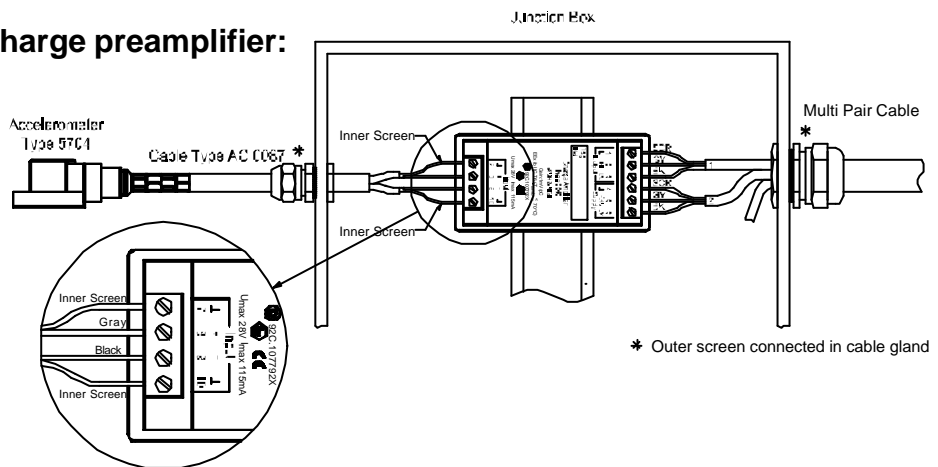

Further information can be found in the Accelerometer Catalogue, BPD0040.

Brüel & Kjær Vibro A/S reserves the right to change specifications without notice