

Model 6054
Calibration Bath
User Manual

© Copyright, 1996

Hart Scientific, Inc.
799 E. Utah Valley Drive
American Fork, UT 84003-9775
(801) 763-1600 Fax: (801) 763-1010

WARNING

To ensure the safety of operating personnel, and to avoid damage to this unit:

DO NOT operate this unit without a properly grounded, properly polarized power cord.
DO NOT connect this unit to a non-grounded, non-polarized outlet.

DO use a ground fault interrupt device.

WARNING

HIGH TEMPERATURES PRESENT

in this equipment.

FIRES and SEVERE BURNS

may result if personnel fail to observe safety precautions.

WARNING

HIGH VOLTAGE

is used in the operation of this equipment.

SEVERE INJURY or DEATH

may result if personnel fail to observe safety precautions.

Before working inside the equipment, turn power off and disconnect power cord.

WARNING

Fluids used in this bath may produce

NOXIOUS OR TOXIC FUMES

under certain circumstances.

Consult the fluid manufacturer's MSDS (Material Safety Data Sheet).

**PROPER VENTILATION AND
SAFETY PRECAUTIONS MUST BE OBSERVED.**

TABLE OF CONTENTS

1	Introduction	9
2	Specifications	10
3	Theory of Operation	11
3.1	Two Modes of Temperature Control	11
3.1.1	The Temperature Control Mode	11
3.1.2	The Temperature Drift Mode:	11
3.1.3	The Fluid system.	11
3.2	Description Of Features and Controls	12
3.2.1	The Controller Panel.	12
3.2.2	The Power Panel.	13
3.2.3	The Rear Panel:	15
4	Installation	16
4.1	Receiving and Inspection	16
4.2	Installation Location Requirements	16
4.2.1	Environment	16
4.2.2	Electrical Power	16
4.2.3	Safety Considerations	16
4.3	Setup.	16
4.3.1	Filling the Bath	16
4.3.1.1	Filling the Bath With Oil	17
4.3.2	Draining the Oil from the Bath	17
5	Operating Instructions	18
5.1	Quick Start.	18
6	Controller Operation	19
6.1	Bath temperature	19
6.2	Reset Cutout.	19
6.3	Temperature Set-point	19
6.3.1	Programmable Set-points	19
6.3.2	Set-point Value.	21
6.3.3	Set-point vernier	21
6.4	Temperature Scale Units.	21
6.5	Secondary Menu.	22
6.6	Heater Power	22
6.7	Proportional Band	22
6.8	Cutout	23

6.9	Controller Configuration	24
6.10	Probe Parameters Menu	24
6.10.1	R0	24
6.10.2	ALPHA	25
6.11	Operating Parameters	25
6.11.1	Cutout Reset Mode	25
6.11.2	Stirrer Mode Select	25
6.11.3	Stirrer set-point.	25
6.12	Serial Interface Parameters	25
6.12.1	BAUD Rate.	26
6.12.2	Sample Period	26
6.12.3	Duplex Mode.	26
6.12.4	Linefeed	26
6.13	IEEE-488 Parameters Menu	26
6.13.1	IEEE-488 Address	27
6.14	Calibration Parameters.	27
6.14.1	CTO	27
6.14.2	CO and CG	27
6.14.3	H and L.	27
6.15	Operation Summary	27
7	Digital Communication Interface	28
7.1	Serial Communications	28
7.1.1	Wiring	28
7.1.2	Setup.	28
7.1.2.1	BAUD rate	28
7.1.2.2	Sample Period	28
7.1.2.3	Duplex Mode.	29
7.1.2.4	Linefeed	29
7.1.3	Serial Operation	29
7.2	IEEE-488 Communication (optional).	29
7.2.1	Setup and Address Selection	29
7.2.2	IEEE-488 Operation	29
7.3	Interface Commands.	29
7.4	Power Commands	31
7.5	Heater Settings for Control.	32
8	Bath Calibration	33
8.1	Calibration Points	33
8.2	Measuring the Set-point Error	34
8.3	Computing R0 and ALPHA	34
8.4	Calibration Example	34
9	Bath Heat Transfer Fluid	35

9.1	Temperature Range	35
9.2	Viscosity	35
9.3	Specific heat	35
9.4	Thermal Conductivity	35
9.5	Thermal Expansion	35
9.6	Electrical Resistivity	35
9.7	Fluid lifetime	36
9.8	Safety	36
9.9	Cost	36
9.9.1	Commonly used fluids	36
9.9.2	Water	36
9.9.3	Ethylene Glycol	36
9.9.4	Mineral Oil	36
9.9.5	Silicone oil	37
9.9.6	Heat Transfer Salt	37
9.10	Fluid Characteristics Charts	39
9.10.1	Limitations and Disclaimer	39
9.10.2	About the Chart	39

10 Troubleshooting 41

10.1	The Heater Indicator LED Stays Red But The Temperature Does Not Increase.	41
10.2	The Controller Display Flashes “CUT-OUT” And The Heater Does Not Operate.	41
10.3	The Display Flashes “CUT-OUT” And An Incorrect Process Temperature.	41
10.4	The Displayed Process Temperature Is In Error And The Controller Remains In The Cooling Or Heating State At Any Set-point Value.	42
10.5	The Controller Controls Or Attempts To Control At An Inaccurate Temperature.	42
10.6	The Controller Shows That The Output Power Is Steady But The Process Temperature Is Unstable.	42
10.7	The Controller Alternately Heats For A While Then Cools.	42
10.8	The Controller Erratically Heats Then Cools, Control Is Unstable.	42

1 Introduction

The Hart Scientific Model 6054 Calibration Bath is a highly stable constant temperature liquid bath. It has been designed for calibrating liquid and glass thermometers or other types of long thermometers against a known temperature standard such as a Standard Platinum Resistance Thermometer (SPRT).

The 6054 calibration bath provides the following features:

- A deep fluid tank (test well is 7.5 inches in diameter and has 24 inches of fluid depth).
- It provides a highly temperature stable low gradient environment typically a nominal stability of $\pm 0.005^{\circ}\text{C}$ with oils. The fluid is well stirred and environmentally protected to minimize gradients.
- The fluid level is near the top of the test well to facilitate calibration of liquid and glass thermometers without needing to compensate for stem effect.
- The bath provides two calibration modes. An electronically controlled mode uses a hybrid digital and analog PI controller with lock in amplifier design. The temperature and other functions are selected with the four button keypad to a hundredth of a degree and finer with a digital vernier adjustment. The Drift mode bypasses the controller with heater power manually controlled with variable transformer.

2 Specifications

Table 1 Specifications

Power Required	230 VAC; 60 Hz; 15 Amps max.
Bath Temperature Range	50°C to 325°C
Temperature Stability.	±0.005°C to 200°C, ±0.010°C to 325°C
Temperature Uniformity	±0.005°C max
Controller Accuracy	±0.5°C
Test Well Area	7.5-inches dia X 24-inches deep
Heater	Electrical, 5 positions; 1=off, 2=250, 3=500, 4=750 & 5=1,000 watts at 240 VAC line
Boost Heater	750watts
Heat Transfer Liquid	Fluids compatible with stainless steel may be used. (e.g. oils such as Dow Corning 710 and 210H or Hart Salt)
Exterior Dimensions	Height 56" X Width 31" X FB 23"
Weight	156 Lbs.

3 Theory of Operation

The components, features and operational theory of the Model 6054 calibration bath are described in this section.

3.1 Two Modes of Temperature Control

Two modes of temperature control are available with the model 6054. The **TEMPERATURE CONTROL** mode or the **TEMPERATURE DRIFT** mode may be selected by a switch on the front panel.

3.1.1 The Temperature Control Mode

The control mode uses a hybrid digital/analog PI temperature controller with lock-in-amplifier. The bath stability is very high with this controller. The temperature is selected using a four button keypad on the front panel. Temperatures from 0.00 to 325.00°C may be selected directly to a hundredth of a degree. Finer adjustment is available using the vernier adjustment. Accuracy of the setting is typically $\pm 0.5^\circ\text{C}$ or better.

The controller pulses AC current to the control heaters in a time modulated fashion to compensate for heat gains and losses to the system. A two color LED on the control panel glows red when the heaters are on and glows green when they are off and cooling is taking place. (Note: The cooling required for control is supplied through heat loss to ambient.)

The Temperature control probe uses a 100 ohm PRT. It is a totally separate unit for ease of replacement. It is inserted into the top of the bath near the stirring motor as shown and plugs into the rear of the control unit.

The heaters are external to the tank. They are arranged electrically to provide the 4 control heating positions plus an off position. The additional boost heating position is accessed from a separate switch on the control panel.

3.1.2 The Temperature Drift Mode:

In the Temperature Drift mode the heater may be set manually to allow the temperature to drift very slowly

(a few milli-°C per minute) over the desired range. This allows the control noise to be eliminated although greater skill is required in making calibrations. The heater power is adjusted by means of a variable transformer located on the control panel. It allows position one of the heater selection switch to be continually variable from 0 to 100% Positions 2, 3, 4 and Boost add their full value of heat incrementally to the adjusted value of position 1.

3.1.3 The Fluid system

The fluid system consists of the insulated tank, the stirrer assembly, the condensate drain, the overflow test well, and the fluid itself. The heaters and probe, which are part of the control system, are physically external to the tank.

The tank and other wetted parts are made of stainless steel for compatibility with most practical thermostating fluids. The stirrer is attached to the tank top plate of the bath and its motor receives additional cooling from a fan to keep from overheating and increase lifetime at high bath temperatures. The stirrer directly drives four 2-inch diameter stirring propellers. The down draft from the propellers forces the bath fluid through the overflow test well. The stirring motor plugs into the rear of the control unit. (See [Figure 3](#) on page 14.)

The over-flow test well serves to provide a constant depth of fluid at an essentially constant height near the well opening. Variations in fluid volume due to thermal expansion and volatilization will not effect measurements within reasonable volume ranges. The fluid expelled from the tank is controlled to flow past the control heaters first before entering the main tank for thermal management.

A drain is provided for convenience in changing the bath fluid. (See draining the tank.)

The condensate drain collects condensed oil vapor and oil that has expanded over the top of the tank walls. Tubes on either side of the drain at the bottom of the bath allow the liquid to be collected into a pan. Be sure this pan is in place at all times to prevent oil from draining onto the floor The condensate pan must be

adequately sized to receive expanded oil during temperature increases (approx. 3 gal).

The recommended bath fluid for the maximum temperature range of the bath is the Dow Corning 710 or 210-H. Other oils may be used. Their properties of specific heat, thermal conductivity, flash point and viscosity as well as economy and convenience should be examined and found acceptable.

See [Section](#) or call Hart Scientific for other potential fluids.

Oils should be drained and replaced if they have decomposed so as to significantly change color, become very viscous, or lower their flash point.

3.2 Description Of Features and Controls

This section will describe the various panels and controls of the model 6054. It will include: 1) the Controller Panel, 2) the Power Panel, and 3) the Back Panel.

The Front Control Panel, which is located just left of the bath, has two sections. The upper section is the Controller Panel ([Figure 1](#)) and the lower is the Power Panel Control ([Figure 2](#)) section.

3.2.1 The Controller Panel

The Controller Panel includes the following features: 1) the digital display, 2) the four button keypad and 3) the control indicator.

1) The digital display is an important part of the temperature controller because it not only displays set and actual temperatures but also various controller functions, settings, and constants. The display shows temperatures in values according to the selected scale °C or °F.

2) The control buttons (SET, DOWN, UP, and EXIT) are used to set the temperature set-point, access and set other operating parameters, and access and set calibration parameters.

Setting the control temperature is done directly in degrees of the current scale. It can be set to one-hundredth of a degree Celsius.

The functions of the buttons are as follows:

SET — Used to display the next parameter in the menu and to set parameters to the displayed value.

DOWN — Used to decrement the displayed value of parameters.

UP — Used to increment the displayed value.

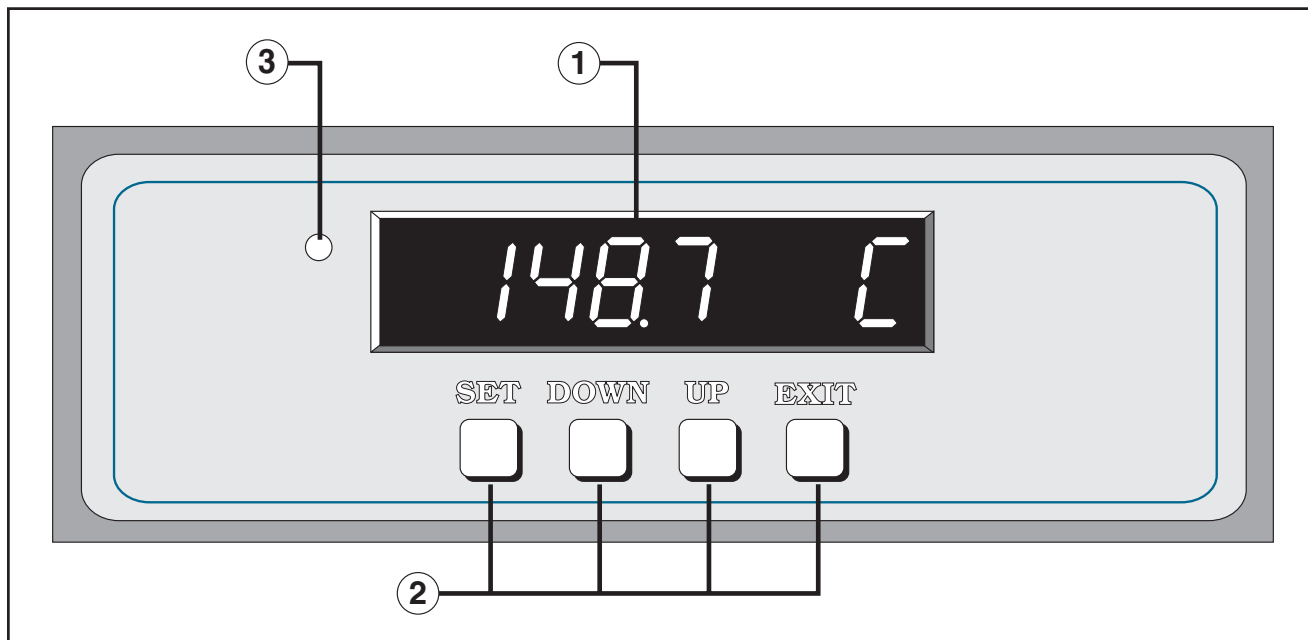

Figure 1 Controller Panel

EXIT — Used to exit from a menu. When EXIT is pressed any changes made to the displayed value will be ignored.

3) The control indicator is a two color light emitting diode (LED). This indicator lets the user visually see the ratio of heating to cooling. When the indicator is red the heater is on, and when it is green the heater is off and the bath is cooling.

3.2.2 The Power Panel

The Power Panel (Figure 2) controls include; 1) The **Mode Select** switch and indicators, 2) the **Drift Adjust** control 3) the control **Heating** select switch, 4) the **Power** switch and indicator, and 5) the **Boost Heater** and indicator.

1) The **MODE SELECT** switch selects between the Temperature Control and Drift Adjust modes. Lights show which mode is functioning. The Temperature Control position selects the temperature controller to operate and the desired temperature is selected on the controller panel. In the Temperature Drift mode

heater control is via the Drift Adjust control and the Heating select switch.

2) The **DRIFT ADJUST** control is a variable transformer that adjusts the Low control heater through 0 to 100% of its power range. The additional power required for higher temperatures may be added in steps by selecting heating positions Medium, Medium High, and High, as required.

3) The control **HEATING** switch selects control heater power positions 1 through 5. Select the lowest reasonable value for normal control conditions depending on bath temperature. The switch simply adds more heaters into the circuit until the desired power is attained. Position 2 is variable using the Drift Adjust control.

4) The **POWER** (On-Off) switch powers up the bath. The switch is a DPST type that opens both legs of the 230 volt power source. A red indicator light shows that power is on.

5) The **BOOST HEATING** provides an additional 750 watts for slewing between temperatures. The Boost Heating Indicator shows whether the boost heater is on or off. The boost heater is powered through the

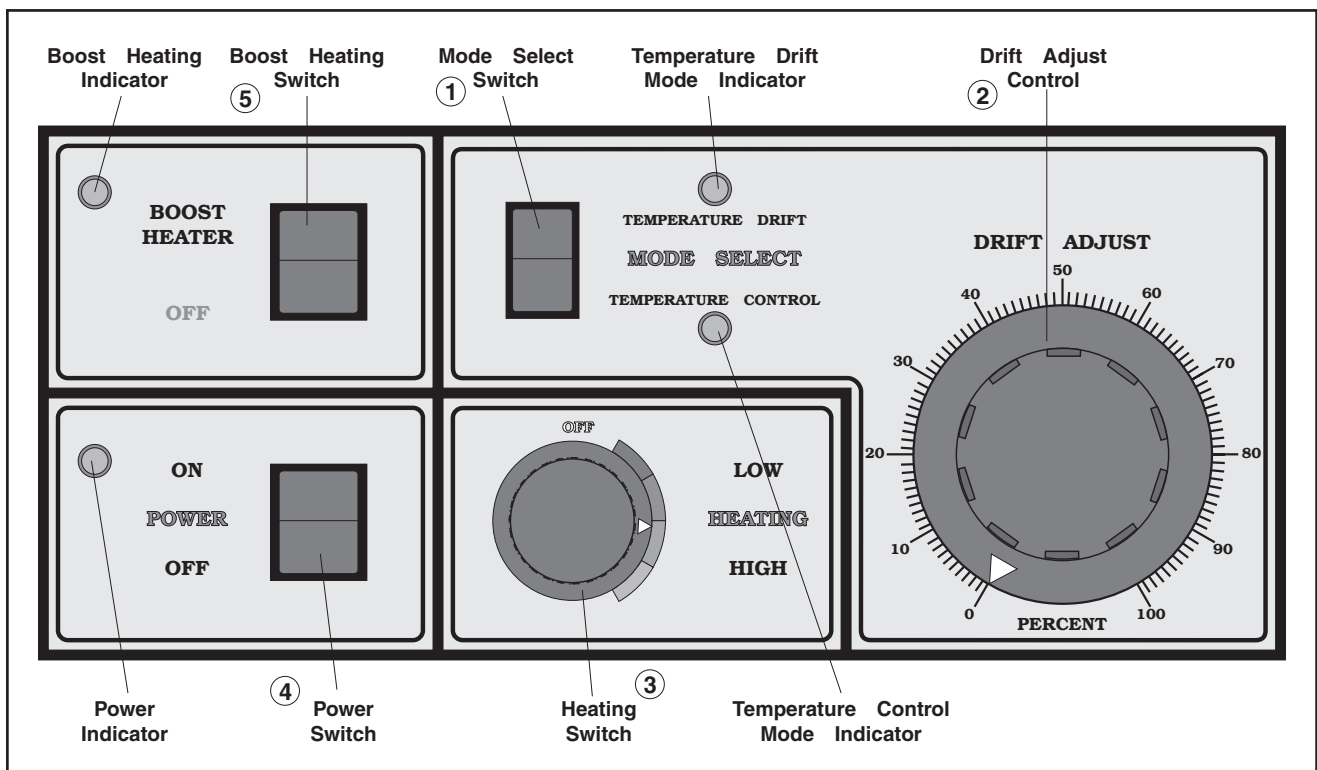

Figure 2 Power panel

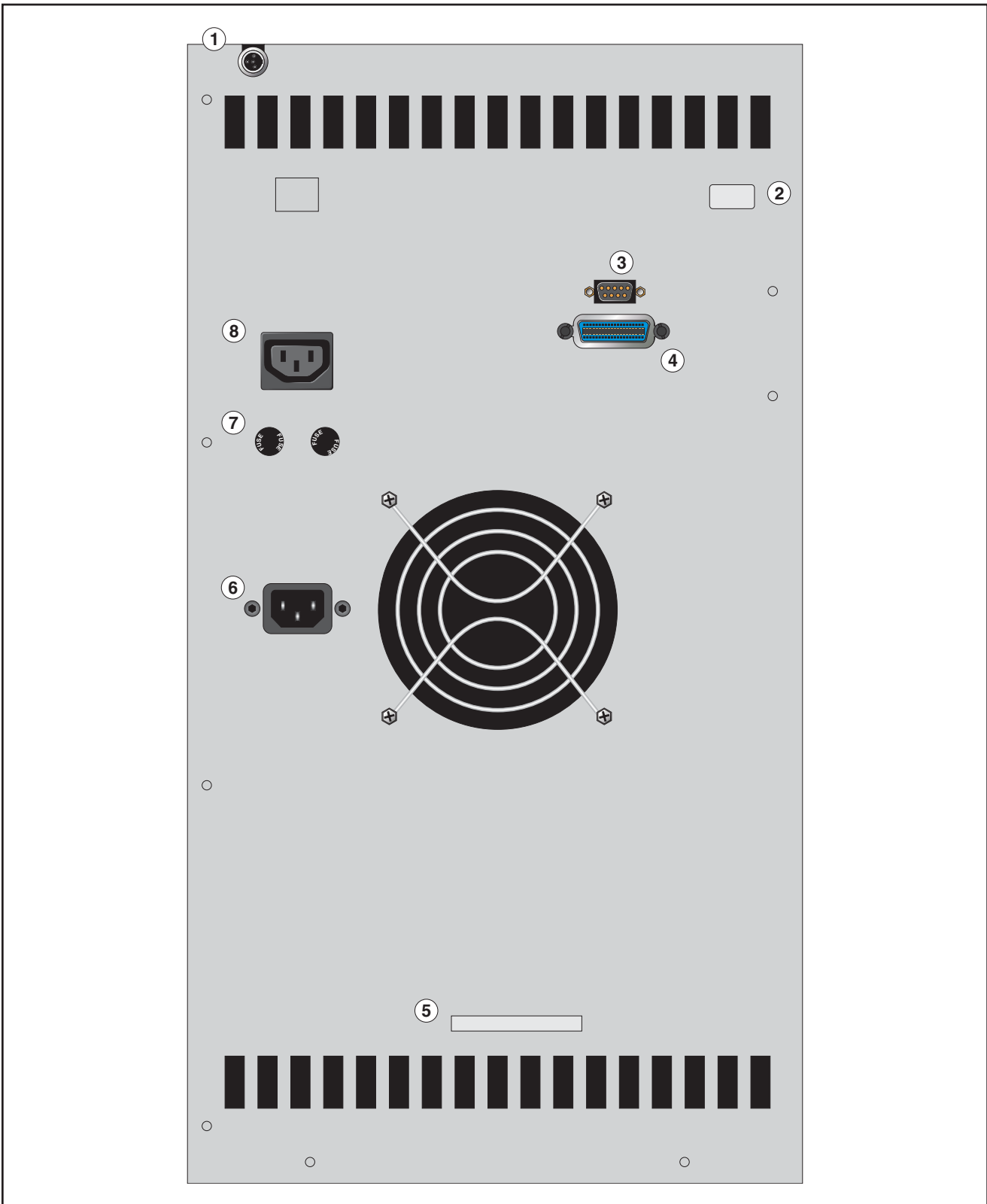

Figure 3 Back panel

temperature controller triac to prevent exceeding the desired set temperature. The boost heater indicator will flash when the set temperature has been reached as a reminder to turn it off for control.

3.2.3 The Rear Panel:

The Rear Panel has many features (see [Figure 3](#)). 1) The **PROBE** connector, 8) **STIRRER POWER** outlet, 7) **FUSES**, 6) Power Connection, 5) **ELECTRONICS FUSE INTERNAL** notation, 2) Unit **SERIAL NO.** notation, 3) optional **SERIAL PORT** and, 4) optional **IEEE-488 PORT**.

1) The **PROBE** connector on the back panel is used for the temperature controller probe.

2) The unit **SERIAL NO.** is located at the top right corner of the back panel. When consulting with the factory, refer to the serial number.

3) **SERIAL PORT** (optional)

4) **IEEE-488 PORT** (optional)

5) The **ELECTRONICS FUSE** is located inside the cabinet and is a 1/4 amp fuse. To replace the electronic fuse, remove the cover over the controller.

6) The **POWER CORD** connector

7) The **SYSTEM FUSES** are 15 amps slow blow (one fuse for each leg of the 230 VAC). The heater fuses are located internally and are 10 amp, 250 VAC.

8) The **STIRRER POWER** connection provides 230 VAC to the stirring motor and its cooling fan.

4 Installation

The Model 6054 bath can be readily installed given due care to the following instructions.

4.1 Receiving and Inspection

Upon receipt of the bath, inspect it to see that there is no obvious damage from shipment. If any damage is observed, notify the carrier at once for an inspector to check out the damage.

Verify that all of the items ordered have been shipped. Notify Hart Scientific immediately if there are any discrepancies.

4.2 Installation Location Requirements

4.2.1 Environment

The model 6054 bath is a precision instrument that must be located in an appropriate environment. The location should be free from drafts, extreme temperatures and temperature changes, dirt, etc. The bath must be level, use the levelers. Allow free air space around the bath to allow surface heat to convect away freely. Ventilation of oil fumes will require a fume hood.

4.2.2 Electrical Power

The bath requires 208-240 VAC single phase power. The higher voltage is used for running the heaters and is required to reduce the current to reasonable levels. ~~The power connected at the junction box on the rear of the bath. The two hot legs are wired to the brown and blue wires, and the ground to the green/yellow wire according to standard convention.~~

4.2.3 Safety Considerations

The Hart model 6054 bath is a high temperature bath. Although safety has been a concern in its design, there are several installation and operational considerations to prevent fire and burns.

Install the bath in an inherently fire safe area. There should not be any material around that will ignite by setting hot probes and thermometers on it or by spillage of the hot bath fluid.

The best floor surface is concrete. If concrete is unavailable, the surface should be protected in some way from inadvertent spillage.

Do Not install the bath near flammable wall materials.

We recommend installing the bath under a fume hood to safely remove oil fumes. It also will help to remove excess heat. It is best to direct oil fumes away from the user when using.

Keep all flammable liquids, fumes, gasses, etc. away from the bath to prevent ignition.

Keep fire safety equipment specific to the type of medium handy in case they are needed.

Safe handling equipment such as leather gloves (such as welding gloves), face shields, long apron etc. are required for reasonable safety.

4.3 Setup

Inspect the probe. It should not be bent or damaged in any way. The probe used with the Model 6054 is a precision PRT sensor.

The probe is to be plugged into its connector on the rear of the bath and inserted fully into the hole located near the stirrer motor inside the motor cover.

Plug the stirrer into the receptacle located on the rear panel of the bath marked STIRRER POWER. This receptacle is switched on with the unit's main power.

Attach a drain line to the overflow drain tube at the rear of the bath behind the stirrer. Use a line compatible with the selected fluid and maximum bath temperature to be used. Run the line to a similarly adequate sump.

4.3.1 Filling the Bath

The bath is shipped dry. Check inside of the test well for foreign matter and remove it to avoid interference with operation.

4.3.1.1 Filling the Bath With Oil

To fill the bath with oil, first be sure the drain is fully closed off. Check the drain assembly for tight fittings. Pour in the heat transfer fluid until it reaches a 1-inch depth from the top of the top plate. Note: Actual depth depends on the thermal expansion of the oil and the anticipated temperature range. The fluid volume of the tank is approximately 2800 cubic inches to the level of the primary overflow. The flowing fluid level

can be adjusted somewhat by adding to or removing fluid. The fluid level during pumping should be flowing over the rim.

The bath is now ready for operation.

4.3.2 Draining the Oil from the Bath

5 Operating Instructions

Operating the model 6054 constant temperature bath is not complex, but must be done according to the following instructions.

The system must be installed and the bath filled according to the instructions in the previous section.

5.1 Quick Start

With the bath fluid in the bath and the control probe in place, the bath is ready to be turned on. When switched on, the stirring motor, the controller displaying the bath temperature, and the heater will come on. Now set the bath to the desired temperature using the buttons to set the temperature controller. This is accomplished by pressing the SET button and then using the UP and DOWN buttons to reach the desired set temperature. Once the set-point desired is displayed, press the SET button to set the bath to the new temperature and then press the EXIT button to return to the temperature display (refer to the Temperature Controller User Flow chart [Figure 4](#)). The bath will heat to the set temperature and begin to control. Allow several minutes for the bath to stabilize at the control set-point.

The heater power switch should be set to the lowest position necessary to provide adequate power to control. Obviously, higher bath temperatures will require higher heater settings. The boost heater may be

switched on to bring the bath up to higher temperatures quickly. It must be switched off when the temperature is reached.

To achieve optimum control stability the proportional band may require adjustment. The ideal proportional band setting varies with temperature, heater setting, and fluid type.

It is advised that you operate the 6054 bath with an access cover or thermometer holder in place. At most temperatures, control stability is improved with the cover in place. At high temperatures, the use of the cover also improves safety.

To accelerate bath cooling after operation at a higher temperature, the access cover may be removed to allow greater air cooling. It also may be possible to make use of a dip chiller or auxiliary cooling coil to decrease cooling times.

If the **Temperature Drift** mode is desired, select that position after adjusting the **Drift Adjust** to 0% to eliminate jumps in temperature, then adjust to the anticipated heating position. Use a bridge and strip chart recorder or other adequate means to establish the desired temperature drift rate as the **Drift Adjust** control is adjusted upward. Select the **LOW** control heater position for the minimum amount of heat and add heat in increments with positions **MEDIUM**, **MEDIUM HIGH** and **HIGH** as needed.

6 Controller Operation

This Section discusses in detail how to operate the bath temperature controller using the front control panel. Using the front panel key switches and LED display the user may monitor the bath temperature, set the temperature set-point in degrees C or F, monitor the heater output power, adjust the controller proportional band, set the cutout set-point, and program the probe calibration parameters, operating parameters, serial and IEEE-488 interface configuration, and controller calibration parameters. Operation of the primary functions is summarized in [Figure 4](#).

6.1 Bath temperature

The digital LED display on the front panel allows direct viewing of the actual bath temperature. This temperature value is what is normally shown on the display. The units, C or F, of the temperature value are displayed at the right. For example,

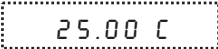
 *Bath temperature in degrees Celsius*

The temperature display function may be accessed from any other function by pressing the “EXIT” button.

6.2 Reset Cutout

If the over-temperature cutout has been triggered then the temperature display will alternately flash,

 *Indicates cut-out condition*

The message will continue to flash until the temperature is reduced and the cutout is reset.

The cutout has two modes — automatic reset and manual reset. The mode determines how the cutout is reset which allows the bath to heat up again. When in automatic mode, the cutout will reset itself as soon as the temperature is lowered below the cutout set-point. With manual reset mode the cutout must be reset by the operator after the temperature falls below the set-point.

When the cutout is active and the cutout mode is set to manual (“reset”) then the display will flash “cutout”

until the user resets the cutout. To access the reset cutout function press the “SET” button.

 Access cutout reset function

The display will indicate the reset function.

 *Cutout reset function*

Press “SET” once more to reset the cutout.

 Reset cutout

This will also switch the display to the set temperature function. To return to displaying the temperature press the “EXIT” button. If the cutout is still in the over-temperature fault condition the display will continue to flash “cutout”. The bath temperature must drop a few degrees below the cutout set-point before the cutout can be reset.

6.3 Temperature Set-point

The bath temperature can be set to any value within the range as given in the specifications with a high degree of resolution. The temperature range of the particular fluid used in the bath must be known by the operator and the bath should only be operated well below the upper temperature limit of the liquid. In addition, the cutout temperature should also be set below the upper limit of the fluid.

Setting the bath temperature involves three steps: (1) select the set-point memory, (2) adjust the set-point value, and (3) adjust the vernier, if desired.

6.3.1 Programmable Set-points

The controller stores 8 set-point temperatures in memory. The set-points can be quickly recalled to conveniently set the bath to a previously programmed temperature.

To set the bath temperature one must first select the set-point memory. This function is accessed from the temperature display function by pressing “SET”. The number of the set-point memory currently being used

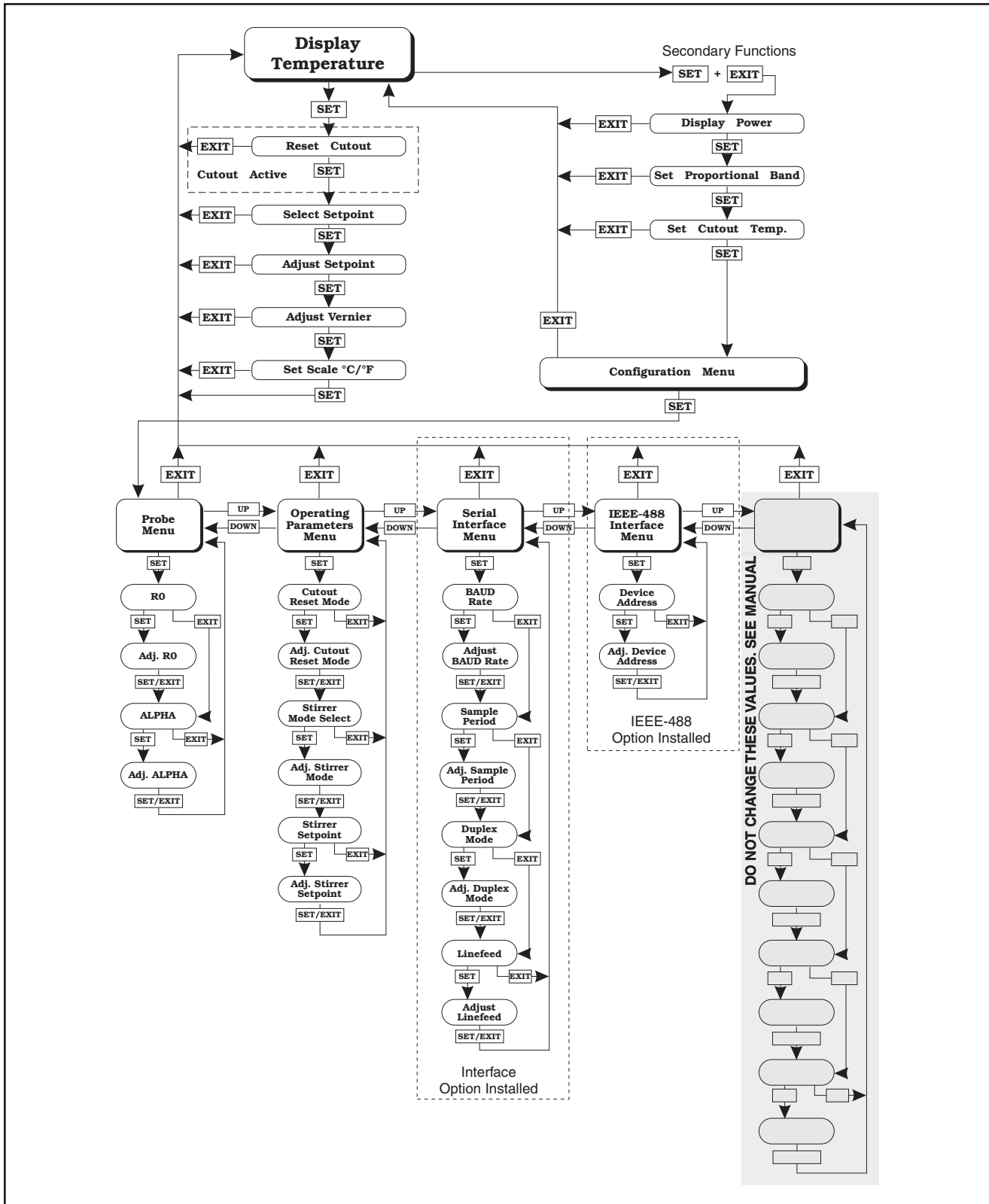



Figure 4 Controller Operation Flowchart

is shown at the left on the display followed by the current set-point value.

 *Bath temperature in degrees Celsius*

 Access set-point memory

 *Set-point memory 1, 25.0°C currently used*

To change the set-point memory press “UP” or “DOWN”.

 Increment memory

 *New set-point memory 4, 40.0°C*

Press “SET” to accept the new selection and access the set-point value.

 Accept selected set-point memory

6.3.2 Set-point Value

The set-point value may be adjusted after selecting the set-point memory and pressing “SET”. The set-point value is displayed with the units, C or F, at the left.

 *Set-point 4 value in°C*

If the set-point value need not be changed then press “EXIT” to resume displaying the bath temperature. To adjust the set-point value press “UP” or “DOWN”.

 Increment display

 *New set-point value*

When the desired set-point value is reached press “SET” to accept the new value and access the set-point vernier. If “EXIT” is pressed instead then any changes made to the set-point will be ignored.

 Accept new set-point value

6.3.3 Set-point vernier

The set-point value can be set with a resolution of 0.01°C. The user may want to adjust the set-point slightly to achieve a more precise bath temperature. The set-point vernier allows one to adjust the temperature below or above the set-point by a small amount with very high resolution. Each of the 8 stored set-points has an associated vernier setting. The vernier is accessed from the set-point by pressing “SET”. The vernier setting is displayed as a 6 digit number with five digits after the decimal point. This is a temperature offset in degrees of the selected units, C or F.

 *Current vernier value in°C*

To adjust the vernier press “UP” or “DOWN”. Unlike most functions the vernier setting has immediate effect as the vernier is adjusted. “SET” need not be pressed. This allows one to continually adjust the bath temperature with the vernier as it is displayed.

 Increment display

 *New vernier setting*

Next press “EXIT” to return to the temperature display or “SET” to access the temperature scale units selection.

 Access scale units

6.4 Temperature Scale Units

The temperature scale units of the controller may be set by the user to degrees Celsius (°C) or Fahrenheit (°F). The units will be used in displaying the bath temperature, set-point, vernier, proportional band, and cutout set-point.

The temperature scale units selection is accessed after the vernier adjustment function by pressing “SET”. From the temperature display function access the units selection by pressing “SET” 4 times.

 *Bath temperature*

 Access set-point memory

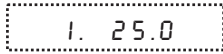
 *Set-point memory*

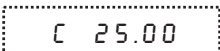
 Access set-point value
 *Set-point value*

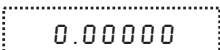
 Access vernier
 *Vernier setting*

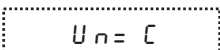
 Access scale units selection
 *Scale units currently selected*

Press “UP” or “DOWN” to change the units.

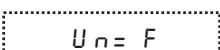
 Change units
 *New units selected*

Press “SET” to accept the new selection and resume displaying the bath temperature.

 Set the new units and resume temperature display

6.5 Secondary Menu



Functions which are used less often are accessed within the secondary menu. The secondary menu is accessed by pressing “SET” and “EXIT” simultaneously and then releasing. The first function in the secondary menu is the heater power display. (See [Figure 4.](#))

6.6 Heater Power

The temperature controller controls the temperature of the bath by pulsing the heater on and off. The total power being applied to the heater is determined by the duty cycle or the ratio of heater on time to the pulse cycle time. This value may be estimated by watching the red/green control indicator light or read directly from the digital display. By knowing the amount of heating the user can tell if the bath is heating up to the set-point, cooling down, or controlling at a constant temperature. Monitoring the percent heater power will let the user know how stable the bath temperature is. With good control stability the

percent heating power should not fluctuate more than $\pm 1\%$ within one minute.

The heater power display is accessed in the secondary menu. Press “SET” and “EXIT” simultaneously and release. The heater power will be displayed as a percentage of full power.

 +  Access heater power in secondary menu

 *Heater power in percent*

To exit out of the secondary menu press “EXIT”. To continue on to the proportional band setting function press “SET”.

 Return to temperature display

6.7 Proportional Band

In a proportional controller such as this the heater output power is proportional to the bath temperature over a limited range of temperatures around the set-point. This range of temperature is called the proportional band. At the bottom of the proportional band the heater output is 100%. At the top of the proportional band the heater output is 0. Thus as the bath temperature rises the heater power is reduced, which consequently tends to lower the temperature back down. In this way the temperature is maintained at a fairly constant temperature.

The temperature stability of the bath depends on the width of the proportional band. See [Figure 5.](#) If the band is too wide the bath temperature will deviate excessively from the set-point due to varying external conditions. This is because the power output changes very little with temperature and the controller cannot respond very well to changing conditions or noise in the system. If the proportional band is too narrow the bath temperature may swing back and forth because the controller overreacts to temperature variations. For best control stability the proportional band must be set for the optimum width.

The optimum proportional band width depends on several factors among which are fluid volume, fluid characteristics (viscosity, specific heat, thermal conductivity), operating temperature, and stirring. Thus the proportional band width may require adjustment for best bath stability when any of these conditions

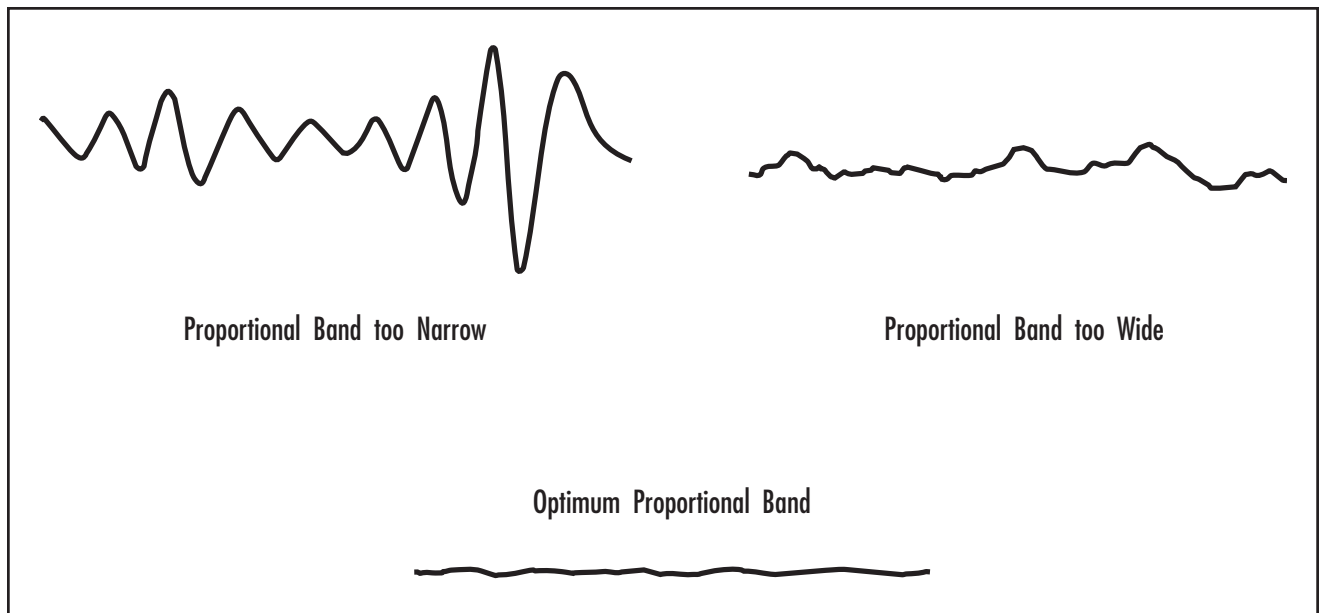



Figure 5 Bath temperature fluctuations at various proportional band settings.

change. Of these, the most significant factors affecting the optimum proportional band width are the fluid viscosity and thermal noise due to difference in temperature between the fluid and ambient. The proportional band should be wider when the fluid viscosity is higher because of the increased response time and also when noise is greater.

The proportional band width is easily adjusted from the bath front panel. The width may be set to discrete values in degrees C or F depending on the selected units. The optimum proportional band width setting may be determined by monitoring the stability with a high resolution thermometer or with the controller percent output power display. Narrow the proportional band width to the point at which the bath temperature begins to oscillate and then increase the band width from this point to 3 or 4 times wider.

The proportional band adjustment may be accessed within the secondary menu. Press “SET” and “EXIT” to enter the secondary menu and show the heater power. Then press “SET” to access the proportional band.

 +  Access heater power in secondary menu

 Heater power in percent

 Access proportional band

 Proportional band setting

To change the proportional band press “UP” or “DOWN”.

 Decrement display

 New proportional band setting

To accept the new setting and access the cutout set-point press “SET”. Pressing “EXIT” will exit the secondary menu ignoring any changes just made to the proportional band value.

 Accept the new proportional band setting



6.8 Cutout

As a protection against software or hardware fault, shorted heater triac, or user error, the bath is equipped with an adjustable heater cutout device that will shut off power to the heater if the bath temperature exceeds a set value. This protects the heater and bath materials from excessive temperatures and,

most importantly, protects the bath fluids from being heated beyond the safe operating temperature preventing hazardous vaporization, breakdown, or ignition of the liquid. The cutout temperature is programmable by the operator from the front panel of the controller. It must always be set below the upper temperature limit of the fluid and no more than 10 degrees above the upper temperature limit of the bath.

If the cutout is activated because of excessive bath temperature then power to the heater will be shut off and the bath will cool. The bath will cool until it reaches a few degrees below the cutout set-point temperature. At this point the action of the cutout is determined by the setting of the cutout mode parameter. The cutout has two modes — automatic reset or manual reset. If the mode is set to automatic, then the cutout will automatically reset itself when the bath temperature falls below the reset temperature allowing the bath to heat up again. If the mode is set to manual, then the heater will remain disabled until the user manually resets the cutout.

The cutout set-point may be accessed within the secondary menu. Press “SET” and “EXIT” to enter the secondary menu and show the heater power. Then press “SET” twice to access the cutout set-point.

 +  Access heater power in secondary menu

 *Heater power in percent*

 Access proportional band

 *Proportional band setting*

 Access cutout set-point

 *Cutout set-point*

To change the cutout set-point press “UP” or “DOWN”.

 Decrement display

 *New cutout set-point*

To accept the new cutout set-point press “SET”.

 Accept cutout set-point

The next function is the configuration menu. Press “EXIT” to resume displaying the bath temperature.

6.9 Controller Configuration

The controller has a number of configuration and operating options and calibration parameters which are programmable via the front panel. These are accessed from the secondary menu after the cutout set-point function by pressing “SET”. The display will prompt with “COnFIG”. Press “SET” once more. There are 5 sets of configuration parameters — probe parameters, operating parameters, serial interface parameters, IEEE-488 interface parameters, and controller calibration parameters. The menus are selected using the “UP” and “DOWN” keys and then pressing “SET”. See [Figure 4](#).

6.10 Probe Parameters Menu

The probe parameter menu is indicated by,

 *Probe parameters menu*

Press “SET” to enter the menu. The probe parameters menu contains the parameters, R0 and ALPHA, which characterize the resistance-temperature relationship of the platinum control probe. These parameters may be adjusted to improve the accuracy of the bath. This procedure is explained in detail in [Section](#).

The probe parameters are accessed by pressing “SET” after the name of the parameter is displayed. The value of the parameter may be changed using the “UP” and “DOWN” buttons. After the desired value is reached press “SET” to set the parameter to the new value. Pressing “EXIT” will cause the parameter to be skipped ignoring any changes that may have been made.

6.10.1 R0

This probe parameter refers to the resistance of the control probe at 0°C. Normally this is set for 100.000 ohms.

6.10.2 ALPHA

This probe parameter refers to the average sensitivity of the probe between 0 and 100°C. Normally this is set for 0.00385°C⁻¹.

6.11 Operating Parameters

The operating parameters menu is indicated by,

`PAR` *Operating parameters menu*

Press “SET” to enter the menu. The operating parameters menu contains the cutout reset mode parameter.

6.11.1 Cutout Reset Mode

The cutout reset mode determines whether the cutout resets automatically when the bath temperature drops to a safe value or must be manually reset by the operator.

The parameter is indicated by,

`CORSE` *Cutout reset mode parameter*

Press “SET” to access the parameter setting. Normally the cutout is set for automatic mode.

`CORSA` *Cutout set for automatic reset*

To change to manual reset mode press “UP” and then “SET”.

`CORSR` *Cutout set for manual reset*

6.11.2 Stirrer Mode Select

This parameter along with the Stirrer set-point allow the user to set the temperature at which the stirrer motor is activated. This setting is generally used when salt is used for the bath medium. For example, you can set the mode to “auto” and the temperature to 200°C. This allows the stirrer motor to shut off and turn on only when the salt is a liquid (>200°C) preventing the stirrer motor from overheating and damage.

The parameter is indicated by,

`SErRct` *Stirrer mode selection parameter*

Press “SET” to access the parameter setting.

`SErRUTO` *Stirrer is set for automatic activation at the stirrer set-point temperature.*

To change the setting to **always on** press the “UP” or “DOWN” buttons and then “SET”. When set to “SErR=ON” the stirrer motor comes on with the bath power regardless of the temperature set in the stirrer set-point parameter.

6.11.3 Stirrer set-point

Allows setting of the temperature above which the stirrer motor will activate when the stirrer activation is set to automatic.

To access the parameter press “SET” from the stirrer activation parameter. set-point mode selection parameter is indicated by,

`SErSEt` *Stirrer motor activation set-point parameter*

Press “SET” to access the parameter value.

`SEr=200` *Stirrer motor activation set-point*

Press “UP” or “DOWN” to change the value and then “SET” to enter the new value.

6.12 Serial Interface Parameters

The serial RS-232 interface parameters menu is indicated by,

`SERIAL` *Serial RS-232 interface parameters menu*

The serial interface parameters menu contains parameters which determine the operation of the serial interface. These controls only apply to baths fitted with the serial interface. The parameters in the menu are — BAUD rate, sample period, duplex mode, and linefeed.

6.12.1 BAUD Rate

The BAUD rate is the first parameter in the menu. The BAUD rate setting determines the serial communications transmission rate.

The BAUD rate parameter is indicated by,

`BAUD` *Serial BAUD rate parameter*

Press “SET” to choose to set the BAUD rate. The current BAUD rate value will then be displayed.

`1200 b` *Current BAUD rate*

The BAUD rate of the bath serial communications may be programmed to 300,600,1200, or 2400 BAUD. Use “UP” or “DOWN” to change the BAUD rate value.

`2400 b` *New BAUD rate*

Press “SET” to set the BAUD rate to the new value or “EXIT” to abort the operation and skip to the next parameter in the menu.

6.12.2 Sample Period

The sample period is the next parameter in the serial interface parameter menu. The sample period is the time period in seconds between temperature measurements transmitted from the serial interface. If the sample rate is set to 5 for instance then the bath will transmit the current measurement over the serial interface approximately every five seconds. The automatic sampling is disabled with a sample period of 0. The sample period is indicated by,

`SAMPLE` *Serial sample period parameter*

Press “SET” to choose to set the sample period. The current sample period value will be displayed.

`SA= 1` *Current sample period (seconds)*

Adjust the value with “UP” or “DOWN” and then use “SET” to set the sample rate to the displayed value.

`SA= 60` *New sample period*

6.12.3 Duplex Mode

The next parameter is the duplex mode. The duplex mode may be set to full duplex or half duplex. With full duplex any commands received by the bath via the serial interface will be immediately echoed or transmitted back to the device of origin. With half duplex the commands will be executed but not echoed. The duplex mode parameter is indicated by,

`dUPL` *Serial duplex mode parameter*

Press “SET” to access the mode setting.

`dUP=FULL` *Current duplex mode setting*

The mode may be changed using “UP” or “DOWN” and pressing “SET”.

`dUP=HALF` *New duplex mode setting*

6.12.4 Linefeed

The final parameter in the serial interface menu is the linefeed mode. This parameter enables (on) or disables (off) transmission of a linefeed character (LF, ASCII 10) after transmission of any carriage-return. The linefeed parameter is indicated by,

`LF` *Serial linefeed parameter*

Press “SET” to access the linefeed parameter.

`LF= ON` *Current linefeed setting*

The mode may be changed using “UP” or “DOWN” and pressing “SET”.

`LF= OFF` *New linefeed setting*

6.13 IEEE-488 Parameters Menu

Baths may optionally be fitted with an IEEE-488 GPIB interface. In this case the user may set the interface address within the IEEE-488 parameter menu. This menu does not appear on baths not fitted with the interface. The menu is indicated by,

IEEE

IEEE-488 parameters menu

Press "SET" to enter the menu.

6.13.1 IEEE-488 Address

The IEEE-488 interface must be configured to use the same address as the external communicating device. The address is indicated by,

Addr E55

IEEE-488 interface address

Press "SET" to access the address setting.

Addr = 22

Current IEEE-488 interface address

Adjust the value with "UP" or "DOWN" and then use "SET" to set the address to the displayed value.

Addr = 15

New IEEE-488 interface address

6.14 Calibration Parameters

The operator of the bath controller has access to a number of the bath calibration constants, namely CTO, C0, CG, H, and L. These values are set at the factory and must not be altered. The correct values are important to the accuracy and proper and safe operation of the bath. Access to these parameters is available to the user only so that in the event that the controller's memory fails the user may restore these values to the factory settings. The user should have a list of these constants and their settings with the manual.

DO NOT change the values of the bath calibration constants from the factory set values. The correct setting of these parameters is important to the safety and proper operation of the bath.

The calibration parameters menu is indicated by,

CAL

Calibration parameters menu

Press "SET" five times to enter the menu.

6.14.1 CTO

Parameter CTO sets the calibration of the over-temperature cutout. This is not adjustable by software but is adjusted with an internal potentiometer. For the 6054 bath this parameter should read between 560 and 570.

6.14.2 CO and CG

These parameters calibrate the accuracy of the bath set-point. These are programmed at the factory when the bath is calibrated. Do not alter the value of these parameters. If the user desires to calibrate the bath for improved accuracy then calibrate R0 and ALPHA according to the procedure given in Section 10.

6.14.3 H and L

These parameters set the upper and lower set-point limits of the bath. DO NOT change the values of these parameters from the factory set values. To do so may present danger of the bath overheating and causing damage or fire.

6.15 Operation Summary

A complete flowchart of controller operation is shown in [Figure 4](#). This chart may be reproduced and used as a reference and operating guide.

7 Digital Communication Interface

If supplied with the option, the 6025/6035 bath is capable of communicating with and being controlled by other equipment through the digital interface. Two types of digital interface are available — the RS-232 serial interface and the IEEE-488 GPIB interface.

7.1 Serial Communications

The bath may be installed with an RS-232 serial interface that allows serial digital communications over fairly long distances. With the serial interface the user may access any of the functions, parameters and settings discussed in Section 6 with the exception of the BAUD rate setting. The serial interface operates with 8 data bits, 1 stop bit, and no parity. The use of a shielded communications cable is recommended.

7.1.1 Wiring

The serial communications cable attaches to the bath through the D-9 connector on the back panel. Figure 6 shows the pin-out of this connector and suggested cable wiring.

7.1.2 Setup

Before operation, the serial interface of the bath must first be set up by programming the BAUD rate and other configuration parameters. These parameters are programmed within the serial interface menu. The serial interface parameters menu is outlined in Figure 4 on page 20.

To enter the serial parameter programming mode first press “EXIT” while pressing “SET” and release to enter the secondary menu. Press “SET” repeatedly until the display reads “Probe”. This is the menu selection. Press “UP” repeatedly until the serial interface menu is indicated with “SERIAL”. Finally press “SET” to enter the serial interface parameters menu. In the serial interface parameters menu are the BAUD rate, sample rate, duplex mode, and linefeed parameters.

7.1.2.1 BAUD rate

The BAUD rate is the first parameter in the menu. The display will prompt with the BAUD rate parameter by

showing “BAUD”. Press “SET” to choose to set the BAUD rate. The current BAUD rate value will then be displayed. The BAUD rate of the serial communications may be programmed to 300, 600, 1200, or 2400 BAUD. The BAUD rate is pre-programmed to 1200 BAUD. Use “UP” or “DOWN” to change the BAUD rate value. Press “SET” to set the BAUD rate to the new value or “EXIT” to abort the operation and skip to the next parameter in the menu.

7.1.2.2 Sample Period

The sample period is the next parameter in the menu and prompted with “SAMPLER”. The sample period is the time period in seconds between temperature measurements transmitted from the serial interface. If the sample rate is set to 5 for instance then the bath will transmit the current measurement over the serial

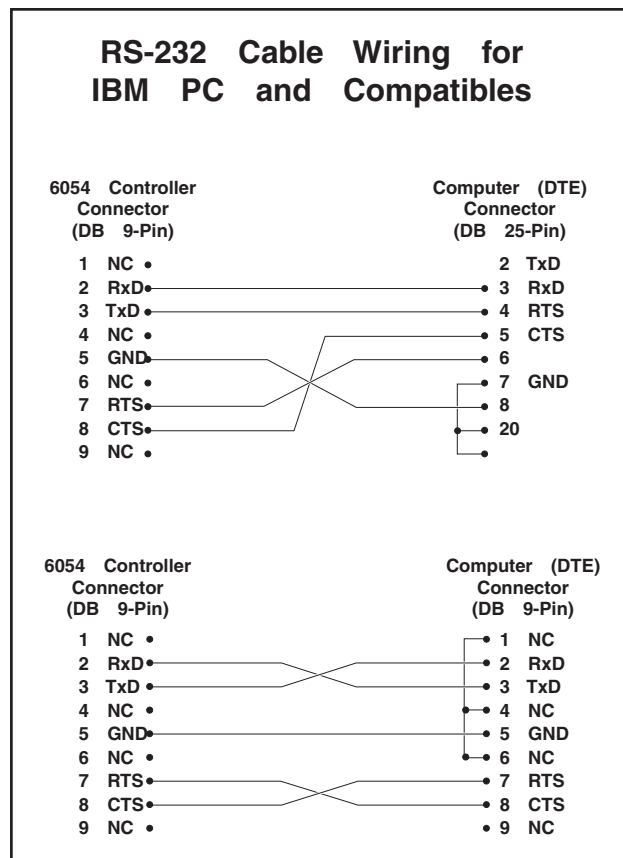

Figure 6 Serial Cable Wiring Diagram

interface approximately every five seconds. The automatic sampling is disabled with a sample period of 0. Press “SET” to choose to set the sample period. Adjust the period with “UP” or “DOWN” and then use “SET” to set the sample rate to the displayed value.

7.1.2.3 Duplex Mode

The next parameter is the duplex mode indicated with “dUPL”. The duplex mode may be set to half duplex (“HALF”) or full duplex (“FULL”). With full duplex any commands received by the bath via the serial interface will be immediately echoed or transmitted back to the device of origin. With half duplex the commands will be executed but not echoed. The default setting is full duplex. The mode may be changed using “UP” or “DOWN” and pressing “SET”.

7.1.2.4 Linefeed

The final parameter in the serial interface menu is the linefeed mode. This parameter enables (“On”) or disables (“OFF”) transmission of a linefeed character (LF, ASCII 10) after transmission of any carriage-return. The default setting is with linefeed on. The mode may be changed using “UP” or “DOWN” and pressing “SET”.

7.1.3 Serial Operation

Once the cable has been attached and the interface set up properly the controller will immediately begin transmitting temperature readings at the programmed rate. The serial interface operates with 8 data bits, 1 stop bit, and no parity. The set-point and other commands may be sent to the bath via the serial interface to set the bath and view or program the various parameters. The interface commands are discussed in [Section 7.3](#). All commands are ASCII character strings terminated with a carriage-return character (CR, ASCII 13).

7.2 IEEE-488 Communication (optional)

The IEEE-488 interface is available as an option. Baths supplied with this option may be connected to a GPIB type communication bus which allows many instruments to be connected and controlled simultaneously.

7.2.1 Setup and Address Selection

To use the IEEE-488 interface first connect an IEEE-488 standard cable to the back of the bath.

Next set the device address. This parameter is programmed within the IEEE-488 interface menu. To enter the IEEE-488 parameter programming menu first press “EXIT” while pressing “SET” and release to enter the secondary menu. Press “SET” repeatedly until the display reaches “PrObE”. This is the menu selection. Press “UP” repeatedly until the IEEE-488 interface menu is indicated with “IEEE”. Press “SET” to enter the IEEE-488 parameter menu. The IEEE-488 menu contains the IEEE-488 address parameter.

The IEEE-488 address is prompted with “AddrESS”. Press “SET” to program the address. The default address is 22. Change the device address of the bath if necessary to match the address used by the communication equipment by pressing “UP” or “DOWN” and then “SET”.

7.2.2 IEEE-488 Operation

Commands may now be sent via the IEEE-488 interface to read or set the temperature or access other controller functions. All commands are ASCII character strings and are terminated with a carriage-return (CR, ASCII 13). Interface commands are listed below.

7.3 Interface Commands

The various commands for accessing the bath controller functions via the digital interfaces are listed in this section (see [Table 2](#)). These commands are used with both the RS-232 serial interface and the IEEE-488 GPIB interface. In either case the commands are terminated with a carriage-return character. The interface makes no distinction between upper and lower case letters, hence either may be used. Commands may be abbreviated to the minimum number of letters which determines a unique command. A command may be used to either set a parameter or display a parameter depending on whether or not a value is sent with the command following a “=” character. For example “s”<CR> will return the current set-point and “s=50.00”<CR> will set the set-point (set-point 1) to 50.00 degrees.

In [Table 2](#), characters or data within brackets, “[” and “]”, are optional for the command. A slash, “/”, denotes

Table 2 Communications Commands

Command Description	Command Format	Command Example	Returned	Returned Example	Acceptable Values
Display Temperature					
Read current set-point	s[etpoint]	s	set: 9999.99 {C or F}	set: 150.00 C	
Set current set-point to <i>n</i>	s[etpoint]= <i>n</i>	s=450			Instrument Range
Read vernier	v[ernier]	v	v: 9.99999	v: 0.00000	
Set vernier to <i>n</i>	v[ernier]= <i>n</i>	v=.00001			Depends on Configuration
Read temperature	t[emperature]	t	t: 9999.99 {C or F}	t: 55.69 C	
Read temperature units	u[nits]	u	u: x	u: c	
Set temperature units:	u[nits]=c/f				C or F
Set temperature units to Celsius	u[nits]=c	u=c			
Set temperature units to Fahrenheit	u[nits]=f	u=f			
Secondary Menu					
Read proportional band setting	pr[op-band]	pr	pr: 999.9	pr: 15.9	
Set proportional band to <i>n</i>	pr[op-band]= <i>n</i>	pr=8.83			Depends on Configuration
Read cutout setting	c[utout]	c	c: 9999 {x},{xxx}	c: 620 C, in	
Set cutout setting:	c[utout]=<i>n</i>/r[eset]				
Set cutout to <i>n</i> degrees	c[utout]= <i>n</i>	c=500			Temperature Range
Reset cutout now	c[utout]=r[eset]	c=r			
Read heater power (duty cycle)	po[wer]	po	po: 9999	po: 1	
Configuration Menu					
Probe Menu					
Read R0 calibration parameter	r[0]	r	r0: 999.999	r0: 100.578	
Set R0 calibration parameter to <i>n</i>	r[0]= <i>n</i>	r=100.324			98.0 to 104.9
Read ALPHA calibration parameter	al[pha]	al	al: 9.9999999	al: 0.0038573	
Set ALPHA calibration parameter to <i>n</i>	al[pha]= <i>n</i>	al=0.0038433			.00370 to .00399
Operating Parameters Menu					
Read cutout mode	cm[ode]	cm	cm: {xxxx}	cm: AUTO	
Set cutout mode:	cm[ode]=r[eset]/a[uto]				RESET or AUTO
Set cutout to be reset manually-	cm[ode]=r[eset]	cm=r			
Set cutout to be reset automatically	cm[ode]=a[uto]	cm=a			
Read Stirrer Mode	smod	smod	smod: {xxxx}	smod: AUTO	
Set Stirrer Mode:	smod=o/a				ON or AUTO
Set strier activation mode to on	smod=o	smod=o			
Set strier activation mode to auto	smod=a	smode=a			
Read Stirrer Set-Point	sset	sset	sset: 9999.99 {C or F}	sset: 160.00C	
Set Stirrer Set-Point to <i>n</i>	sset= <i>n</i>	sset=160			instrument range
Serial Interface Menu					
Read serial sample setting	sa[mple]	sa	sa: 9	sa: 1	
Set serial sampling setting to <i>n</i> seconds	sa[mple]= <i>n</i>	sa=0			0 to 4000
Set serial duplex mode:	du[plex]=f[ull]/h[alf]				FULL or HALF
Set serial duplex mode to full	du[plex]=f[ull]	du=f			
Set serial duplex mode to half	du[plex]=h[alf]	du=h			
Set serial linefeed mode:	lf[eed]=on/of[f]				ON or OFF

Communications Commands, cont.

Command Description	Command Format	Command Example	Returned	Returned Example	Acceptable Values
Set serial linefeed mode to on	lf[eed]=on	lf=on			
Set serial linefeed mode to off	lf[eed]=off	lf=of			
Calibration Menu					
Read C0 calibration parameter	*c0	*c0	c0: 9	c0: 0	
Set C0 calibration parameter to <i>n</i>	*c0= <i>n</i>	*c0=0			-999.9 to 999.9
Read CG calibration parameter	*cg	*cg	cg: 999.99	cg: 406.25	
Set CG calibration parameter to <i>n</i>	*cg= <i>n</i>	*cg=406.25			-999.9 to 999.9
Read low set-point limit value	*tl[ow]	*tl	tl: 999	tl: -80	
Set low set-point limit to <i>n</i>	*tl[ow]= <i>n</i>	*tl=-80			-999.9 to 999.9
Read high set-point limit value	*th[igh]	*th	th: 999	th: 205	
Set high set-point limit to <i>n</i>	*th[igh]= <i>n</i>	*th=205			-999.9 to 999.9
Miscellaneous (not on menus)					
Read firmware version number	*ver[sion]	*ver	ver.9999,9.99	ver.2100,3.56	
Read structure of all commands	h[elp]	h	list of commands		
Read Heater 1	f1	f1	f1:9	f1:1	
Set Heater 1	f1=1/0				1 or 0
Set heater 1 to on	f1= <i>n</i>	f1=1			
Set heater 1 to off	f1= <i>n</i>	f1=0			
Read Heater 2	f2	f2	f2:9	f2:0	
Set Heater 2	f2=1/0				1 or 0
Set Heater 2 to on	f2= <i>n</i>	f2=1			
Set Heater 2 to off	f2= <i>n</i>	f2=0			
Read Heater 3	f3	f3	f3:9	f3:1	
Set Heater 3	f3=1/0				1 or 0
Set Heater 3 to on	f3= <i>n</i>	f3=1			
Set Heater 3 to off	f3= <i>n</i>	f3=0			
Read Heater 4	f4	f4	f4:9	f4:1	
Set Heater 4	f4=1/0				1 or 0
Set Heater 4 to on	f4= <i>n</i>	f4=1			
Set Heater 4 to off	f4= <i>n</i>	f4=0			
Read Boost Heater	f5	f5	f5:9	f5:1	
Set Boost Heater	f5=1/0				1 or 0
Set Boost Heater to on	f5= <i>n</i>	f5=1			
Set Boost Heater to off	f5= <i>n</i>	f5=0			
Legend:	[] Optional Command data				
	{ } Returns either information				
	<i>n</i> Numeric data supplied by user				
	9 Numeric data returned to user				
	x Character data returned to user				
Note:	When DUPLEX is set to FULL and a command is sent to READ, the command is returned followed by a carriage return and linefeed. Then the value is returned as indicated in the RETURNED column.				

alternate characters or data. Numeric data, denoted by “n”, may be entered in decimal or exponential notation. Bold type characters are literal characters while normal type symbolizes data. Characters are shown in lower case although upper case may be used. Spaces may be added within command strings and will simply be ignored. Backspace (BS, ASCII 8) may be used to erase the previous character. A terminating CR is implied with all commands.

7.4 Power Commands

The digital interface is capable of controlling the heating functions so that the bath can be remotely operated at any temperature within the range of the bath. *To allow the interface to control the heating, the front panel controls are disabled by 1) switching the heater control to “OFF”, and 2) switching the boost heater*

switch to “OFF”. Otherwise, the interface would not be able to switch these functions off. The 6054 bath has five control functions with the digital interface. These are controls for heaters 1, 2, 3, and 4, each 250 W, and the boost heater which is 1000 W. Heater 1 power is variable with the DRIFT control on the front panel. The boost heater should only be used for quickly heating the bath up to a high temperature and not for controlling at a constant temperature.

Serial commands “F1” through “F5” control the heaters 1 through 4 and the boost heater individually. These commands are used to turn the heaters on or off or to read the states of the heaters. Sending a command with parameter “1” turns the heater on. Parameter “0” turns the heater off. No parameter returns the state, “1” for on or “0” for off. For example “F1=1”<RETURN> turns on heater 1. “F1”<RETURN> (no pa-

rameter) will return “f1:1” or “f1:0” depending on whether heater 1 is on or off respectively.

Since unlike the front panel heater control, which turns on multiple heaters to achieve the desired power level, the interface commands control the heaters individually, multiple commands must be issued to set the desired amount of power. Table 4 lists the commands which should be given to set various power levels. Power is variable with the front panel DRIFT control when heater 1 (F1) is turned on.

7.5 Heater Settings for Control

Suggested heater control settings for various ranges are suggested in Table 5 below.

Table 4 Heater Power Settings

POWER	F1	F2	F3	F4	F5
OFF	0	0	0	0	0
0–250 W LOW	1	0	0	0	0
250–500 W MEDIUM	1	1	0	0	0
500–750 W MEDIUM HIGH	1	1	1	0	0
750–1000 W HIGH	1	1	1	1	0
‘750 W BOOST	1	1	1	1	1

Table 5 Suggested Heater Settings

Range	Controls
50°C–125°C	LOW - Heater 1 on, heaters 2–4 and boost heater off
125°C–200°C	MEDIUM - Heaters 1 and 2 on, heater 3, 4, and boost heater off
200°C–275°C	MEDIUM HIGH - Heaters 1–3 on and heater 4 and boost heater off
275°C–325°C	HIGH - Heaters 1–4 and boost heater on

8 Bath Calibration

In some instances the user may want to calibrate the bath to improve the temperature set-point accuracy. Calibration is done by adjusting the controller probe calibration constants R_0 and ALPHA so that the temperature of the bath as measured with a standard thermometer agrees more closely with the bath set-point. The thermometer used must be able to measure the bath fluid temperature with higher accuracy than the desired accuracy of the bath. By using a good thermometer and carefully following procedure the bath can be calibrated to an accuracy of better than 0.02°C over a range of 100 degrees.

8.1 Calibration Points

In calibrating the bath R_0 and ALPHA are adjusted to minimize the set-point error at each of two different bath temperatures. Any two reasonably separated bath temperatures may be used for the calibration however best results will be obtained when using bath temperatures which are just within the most useful operating range of the bath. The further apart the calibration temperatures the larger will be the calibrated temperature range but the calibration error will also be greater over the range. If for instance 50°C and 150°C are chosen as the calibration temperatures then the bath may achieve an accuracy of say $\pm 0.03^\circ\text{C}$ over the range 40 to 160°C . Choosing 80°C

$$R_0 = 100.000$$

$$\text{ALPHA} = 0.0038500$$

$$t_L = 80.00^\circ\text{C}$$

$$\text{measured } t = 79.843^\circ\text{C}$$

$$t_H = 120.00^\circ\text{C}$$

$$\text{measured } t = 119.914^\circ\text{C}$$

Compute errors,

$$\text{err}_L = 79.843 - 80.00^\circ\text{C} = -0.157^\circ\text{C}$$

$$\text{err}_H = 119.914 - 120.00^\circ\text{C} = -0.086^\circ\text{C}$$

Compute R_0 ,

$$R_0' = \left[\frac{(-0.086) \times 80.0 - (-0.157) \times 120.0}{120.0 - 80.0} 0.00385 + 1 \right] 100.000 = 100.115$$

Compute ALPHA,

$$\text{ALPHA}' = \left[\frac{(1 + 0.00385 \times 120.0)(-0.157) - (1 + 0.00385 \times 80.0)(-0.086)}{120.0 - 80.0} + 1 \right] 0.00385 = 0.0038387$$

Figure 7 Calibration Example

and 120°C may allow the bath to have a better accuracy of maybe $\pm 0.01^\circ\text{C}$ over the range 75 to 125°C but outside that range the accuracy may be only $\pm 0.05^\circ\text{C}$.

8.2 Measuring the Set-point Error

The first step in the calibration procedure is to measure the temperature errors (including sign) at the two calibration temperatures. First set the bath to the lower set-point which we will call t_L . Wait for the bath to reach the set-point and allow 15 minutes to stabilize at that temperature. Check the bath stability with the thermometer. When both the bath and the thermometer have stabilized measure the bath temperature with the thermometer and compute the temperature error err_L which is the actual bath temperature minus the set-point temperature. If for example the bath is set for a lower set-point of $t_L=50^\circ\text{C}$ and the bath reaches a measured temperature of 49.7°C then the error is -0.3°C .

Next, set the bath for the upper set-point t_H and after stabilizing measure the bath temperature and compute the error err_H . For our example we will suppose the bath was set for 150°C and the thermometer measured 150.1°C giving an error of $+0.1^\circ\text{C}$.

8.3 Computing R0 and ALPHA

Before computing the new values for R0 and ALPHA the current values must be known. The values may be found by either accessing the probe calibration menu from the controller panel or by inquiring through the digital interface. The user should keep a record of these values in case they may need to be restored in

the future. The new values R0' and ALPHA' are computed by entering the old values for R0 and ALPHA, the calibration temperature set-points t_L and t_H , and the temperature errors err_L and err_H into the following equations,

$$R0' = \left[\frac{err_H t_L - err_L t_H}{t_H - t_L} ALPHA + 1 \right] R0$$

$$ALPHA' = \left[\frac{(1 + ALPHA t_H)err_L - (1 + ALPHA t_L)err_H}{t_H - t_L} + 1 \right] ALPHA$$

If for example R0 and ALPHA were previously set for 100.000 and 0.0038500 respectively and the data for t_L , t_H , err_L , and err_H were as given above then the new values R0' and ALPHA' would be computed as 100.193 and 0.0038272 respectively. Program the new values R0 and ALPHA into the controller. Check the calibration by setting the temperature to t_L and t_H and measuring the errors again. If desired the calibration procedure may be repeated again to further improve the accuracy.

8.4 Calibration Example

The bath is to be used between 75 and 125°C and it is desired to calibrate the bath as accurately as possible for operation within this range. The current values for R0 and ALPHA are 100.000 and 0.0038500 respectively. The calibration points are chosen to be 80.00 and 120.00°C. The measured bath temperatures are 79.843 and 119.914°C respectively. Refer to [Figure 7](#) for applying equations to the example data and computing the new probe constants.

9 Bath Heat Transfer Fluid

Many fluids will work with 6054 bath. Choosing a fluid requires consideration of many important characteristics of the fluid. Among these are temperature range, viscosity, specific heat, thermal conductivity, thermal expansion, electrical conductivity, fluid lifetime, safety, and cost.

9.1 Temperature Range

One of the most important characteristics to consider is the temperature range of the fluid. Few fluids work well throughout the entire temperature range of the bath. The temperature at which the bath is operated must always be within the safe and useful temperature range of the fluid used. The lower temperature range of the fluid is determined either by the freeze point of the fluid or the temperature at which the viscosity becomes too great. The upper temperature is usually limited by vaporization, flammability, or chemical breakdown of the fluid. Vaporization of the fluid at higher temperatures may adversely affect temperature stability because of cool condensed fluid dripping into the bath from the lid.

The bath temperature should be limited by setting the safety cutout so that the bath temperature cannot exceed the safe operating temperature limit of the fluid.

9.2 Viscosity

Viscosity is a measure of the thickness of a fluid or how easily it can be poured and mixed. Viscosity affects the temperature uniformity and stability of the bath. With lower viscosity, fluid mixing is better therefore creating a more uniform temperature throughout the bath. This improves the bath response time which allows it to maintain a more constant temperature. For good control the viscosity should be less than 10 centistokes. The practical upper limit of allowable viscosity is about 50 centistokes. Viscosity greater than this causes very poor control stability because of poor stirring and may also overheat or damage the stirring motor. Viscosity may vary greatly with temperature, especially with oils.

When using fluids with higher viscosities the controller proportional band may need to be increased to

compensate for the reduced response time. Otherwise the temperature may begin to oscillate.

9.3 Specific heat

Specific heat is the measure of the heat storage ability of the fluid. Specific heat, to a small degree, affects the control stability. It also affects the heating and cooling rates. Generally, a lower specific heat means quicker heating and cooling. The proportional band may require some adjustment depending on the specific heat of the fluid.

9.4 Thermal Conductivity

Thermal conductivity measures how easily heat flows through the fluid. Thermal conductivity of the fluid affects the control stability, temperature uniformity, and temperature settling time. Fluids with higher conductivity distribute heat more quickly and evenly improving bath performance.

9.5 Thermal Expansion

Thermal expansion describes how much the volume of the fluid changes with temperature. Thermal expansion of the fluid must be considered since the increase in fluid volume as the bath temperature increases may cause overflow. Excessive thermal expansion may also be undesirable in applications where constant liquid level is important. Many fluids including oils have significant thermal expansion.

9.6 Electrical Resistivity

Electrical resistivity describes how well the fluid insulates against the flow of electric current. In some applications, such as measuring the resistance of bare temperature sensors, it may be important that little or no electrical leakage occur through the fluid. In such conditions choose a fluid with very high electrical resistivity.

9.7 Fluid lifetime

Many fluids degrade over time because of vaporization, water absorption, gelling, or chemical breakdown. Often the degradation becomes significant near the upper temperature limit of the fluid, substantially reducing the fluid's lifetime.

9.8 Safety

When choosing a fluid always consider the safety issues associated. Obviously where there are extreme temperatures there can be danger to personnel and equipment. Fluids may also be hazardous for other reasons. Some fluids may be considered toxic. Contact with eyes, skin, or inhalation of vapors may cause injury. A proper fume hood must be used if hazardous or bothersome vapors are produced.

Fluids may be flammable and require special fire safety equipment and procedures.

An important characteristic of the fluid to consider is the flash point. The flash point is the temperature at which there is sufficient vapor given off so that when there is adequate oxygen present and an ignition source is applied the vapor will ignite. This does not necessarily mean that fire will be sustained at the flash point. The flash point may be either of the open cup or closed cup type. Either condition may occur in a bath situation.

The open cup flash point is measured under the condition of vapors escaping the tank. The closed cup flash point is measured with the vapors being contained within the tank. Since oxygen and an ignition source is less available inside the tank the closed cup flash point will be lower than the open cup flash point.

Remember also that environmentally hazardous fluids require special disposal according to applicable federal or local laws after use.

9.9 Cost

Cost of bath fluids may vary greatly, from cents per gallon for water to hundreds of dollars per gallon for synthetic oils. Cost may be an important consideration when choosing a fluid.

9.9.1 Commonly used fluids

Below is a description of some of the more commonly used fluids and their characteristics.

9.9.2 Water

Water is often used because of its very low cost, its availability, and its excellent temperature control characteristics. Water has very low viscosity and good thermal conductivity and heat capacity which makes it among the best fluids for good control stability at lower temperatures. Temperature stability is much poorer at higher temperatures because water condenses on the lid, cools and drips into the bath. Water is safe and relatively inert. The electrical conductivity of water may prevent its use in some applications. Water has a limited temperature range, from a few degrees above 0°C to a few degrees below 100°C. At higher temperatures evaporation becomes significant. Water used in the bath should be distilled or deionized to prevent mineral deposits. Consider using an algicide chemical in the water to prevent contamination.

9.9.3 Ethylene Glycol

The temperature range of water may be extended by using a solution of 1 part water and 1 part ethylene glycol (antifreeze). The characteristics of the ethylene glycol-water solution are similar to water but with higher viscosity. Use caution with ethylene glycol since this fluid is very toxic. Ethylene glycol must be disposed of properly.

9.9.4 Mineral Oil

Mineral oil or paraffin oil is often used at moderate temperatures above the range of water. Mineral oil is relatively inexpensive. At lower temperatures mineral oil is quite viscous and control may be poor. At higher temperatures vapor emission becomes significant. The vapors may be dangerous and use of a fume hood is highly recommended. As with most oils, mineral oil will expand as temperature increases, therefore, be careful not to fill the bath too full that it overflows when heated. The viscosity and thermal characteristics of mineral oil is poorer than water so temperature stability will not be as good. Mineral oil has very low electrical conductivity. Use caution with

Table 6 Table of Bath Fluids

Fluid (# = Hart Part No.)	Lower Temperature Limit*	Upper Temperature Limit*	Flash Point	Viscosity (centistokes)	Specific Gravity	Specific Heat (cal/g/°C)	Thermal Conductivity (cal/s/cm ² /°C)	Thermal Expansion (cm/cm/°C)	Resistivity (10 ¹² Ω-cm)
Halocarbon 0.8 #5019	-90°C (v)**	70°C (e)	NONE	5.7 @ -50°C 0.8 @ 40°C 0.5 @ 70°C	1.71 @ 40°C	0.2	0.0004	0.0011	
Methanol	-96°C (fr)	60°C (b)	54°C	1.3 @ -35°C 0.66 @ 0°C 0.45 @ 20°C	0.810 @ 0°C 0.792 @ 20°C	0.6	0.0005 @ 20°C	0.0014 @ 25°C	
Water	0°C (fr)	95°C (b)	NONE	1 @ 25°C 0.4 @ 75°C	1.00	1.00	0.0014	0.0002 @ 25°C	
Ethylene Glycol—50% #5020	-35°C (fr)	110°C (b)	NONE	7 @ 0°C 2 @ 50°C 0.7 @ 100°C	1.05	0.8 @ 0°C	0.001		
Mineral Oil	40°C (v)	190°C (fl)	190°C	15 @ 75°C 5 @ 125°C	0.87 @ 25°C 0.84 @ 75°C 0.81 @ 125°C	0.48 @ 25°C 0.53 @ 75°C 0.57 @ 125°C	0.00025 @ 25°C	0.0007 @ 50°C	5 @ 25°C
Dow Corning 200.5 Silicone Oil	-40°C (v)**	133°C (fl, cc)	133°C	5 @ 25°C	0.92 @ 25°C	0.4	0.00028 @ 25°C	0.00105	1000 @ 25°C 10 @ 150°C
Dow Corning 200.10 #5012	-35°C (v)**	165°C (fl, cc)	165°C	10 @ 25°C 3 @ 135°C	0.934 @ 25°C	0.43 @ 40°C 0.45 @ 100°C 0.482 @ 200°C	0.00032 @ 25°C	0.00108	1000 @ 25°C 50 @ 150°C
Dow Corning 200.20 #5013	7°C (v)	230°C (fl, cc)	230°C	20 @ 25°C	0.949 @ 25°C	0.370 @ 40°C 0.393 @ 100°C 0.420 @ 200°C	0.00034 @ 25°C	0.00107	1000 @ 25°C 50 @ 150°C
Dow Corning 200.50 Silicone Oil	25°C (v)	280°C (fl, cc)	280°C	20 @ 25°C	0.96 @ 25°C	0.4	0.00037 @ 25°C	0.00104	1000 @ 25°C 50 @ 150°C
Dow Corning 550 #5016	70°C (v)	232°C (fl, cc) 300°C (fl, oc)	232°C	50 @ 70°C 10 @ 104°C	1.07 @ 25°C	0.358 @ 40°C 0.386 @ 100°C 0.433 @ 200°C	0.00035 @ 25°C	0.00075	100 @ 25°C 1 @ 150°C
Dow Corning 710 #5017	80°C (v)	302°C (fl, oc)	302°C	50 @ 80°C 7 @ 204°C	1.11 @ 25°C	0.363 @ 40°C 0.454 @ 100°C 0.505 @ 200°C	0.00035 @ 25°C	0.00077	100 @ 25°C 1 @ 150°C
Dow Corning 210-H Silicone Oil	66°C (v)	315°C (fl, oc)	315°C	50 @ 66°C 14 @ 204°C	0.96 @ 25°C	0.34 @ 100°C	0.0003	0.00095	100 @ 25°C 1 @ 150°C

mineral oil since it is flammable and may also cause serious injury if inhaled or ingested.

very high electrical resistivity. Silicone oils are fairly safe and non-toxic. Silicone oils are fairly expensive.

9.9.5 Silicone oil

Silicone oils are available which offer a much wider operating temperature range than mineral oil. Like most oils, silicone oils have temperature control characteristics which are somewhat poorer than water. The viscosity changes significantly with temperature and thermal expansion also occurs. These oils have

9.9.6 Heat Transfer Salt

Heat transfer salt is often used at high bath temperatures. Salt has a very high upper temperature limit and a wide useful temperature range. Salt may be used from its freezing point at 145°C up to the upper temperature limit of the bath. Viscosity is low, especially at higher temperatures. Salt when melted has very low electrical resistivity. Salt may be corrosive to some

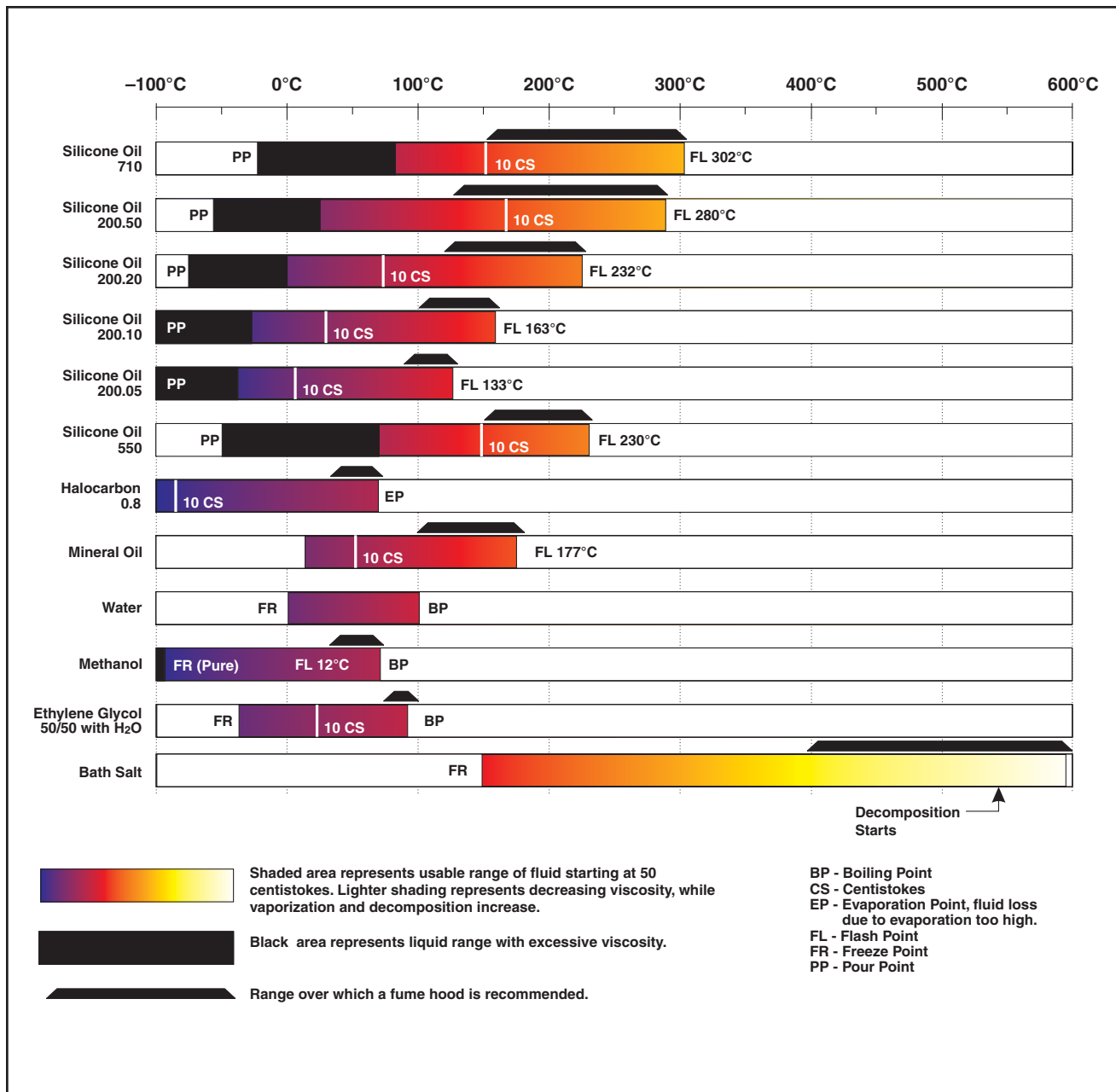

Figure 8 Chart showing usable range of various fluids.

materials. Salt will quickly oxidize the coating on galvanized metal. Carbon steel may be used with salt up to 450°C. Beyond this temperature stainless steel is recommended.

CAUTION: Keep all combustible materials away from the bath when using salt. Operate the bath on a heat-proof surface such as concrete. Provide a means of safely containing any spills which may occur.

The greatest safety concern with liquid salt is with its high temperature. The fluid provides a source of heat

which can ignite or destroy materials. Especially dangerous are spills since the hot fluid is difficult to contain. Salt may also cause steam explosions if it comes into contact with water. Using salt requires special caution. Read carefully the information and safety data sheets provided with the salt. Use of a fume hood is recommended to remove any products of decomposition or oxidation.

Because salt is solid at room temperature special procedures are required in using the bath with salt. The bath has been designed so that the stir motor will not turn on until the bath has reached the temperature for the salt to liquify.

Solid salt has poor thermal conductivity. Only operate the bath with the "HEATER" switch on position "LOW" until the salt is melted. Using higher heater power may over-heat and damage the bath heaters. The heaters will only run at 25% power until the bath reaches 200°C. This helps to protect the heaters during melting of the salt. This is especially possible when heating salt which has solidified and contracted leaving gaps between the bath walls and the salt.

Salt is supplied in a pink granular form. Fill the bath gradually as the salt heats and melts. Because of the heat required to melt the salt this is a slow process and may take 10 hours or more. Fill the bath until the liquid is a few inches below the lid. The level will rise as much as two inches as it is heated to the upper temperature limit.

9.10 Fluid Characteristics Charts

Table 6 and Figure 8 on pages 37 and 38 have been created to provide help in selecting a heat exchange fluid media for your constant temperature bath. These charts provide both a visual and numerical representation of most of the physical qualities important in making a selection. The list is not all inclusive. There may be other useful fluids not shown in this listing.

The charts include information on a variety of fluids which are often used as heat transfer fluid in baths. Because of the temperature range some fluids may not be useful with your bath.

9.10.1 Limitations and Disclaimer

The information given in this manual regarding fluids is intended only to be used as a general guide in choosing a fluid. Though every effort has been made to provide correct information we cannot guarantee accuracy of data or assure suitability of a fluid for a particular application. Specifications may change and sources sometimes offer differing information. Hart Scientific cannot be liable for any personal injury or damage to equipment, product or facilities resulting from the use of these fluids. The user of the bath is responsible for collecting correct information, exercising proper judgement, and insuring safe operation. Operating near the limits of certain properties such as the flash point or viscosity can compromise safety or performance. Your company's safety policies regarding flash points, toxicity, and such issues must be considered. You are responsible for reading the MSDS (material safety data sheets) and acting accordingly.

9.10.2 About the Chart

The fluid chart (Figure 8 on page 38) visually illustrates some of the important qualities of the fluids shown.

Temperature Range: The temperature scale is shown in degrees Celsius. The fluids' general range of application is indicated by the shaded bands. Qualities including pour point, freeze point, important viscosity points, flash point, boiling point and others may be shown.

Freezing Point: The freezing point of a fluid is an obvious limitation to stirring. As the freezing point is approached high viscosity may also limit performance.

Pour Point: This represents a handling limit for the fluid.

Viscosity: Points shown are at 50 and 10 centistokes viscosity. When viscosity is greater than 50 centistokes stirring is very poor and the fluid is unsatisfactory for bath applications. Optimum stirring generally occurs at 10 centistokes and below.

Fume Point: This is the point at which a fume hood is recommended. This point is very subjective in nature and is impacted by individual tolerance to different fumes and smells, how well the bath is covered, the surface area of the fluid in the bath, the size and ventilation of the facility where the bath is located and other

Bath Heat Transfer Fluid

conditions. We assume the bath is well covered at this point. This is also subject to company policy.

Flash Point: This is the point at which ignition may occur. The point shown may be either the open or closed cup flash point. Refer to the flash point discussion in [Section](#).

Boiling Point: At or near the boiling point of the fluid the temperature stability is difficult to maintain.

Fuming or evaporation is excessive. Large amounts of heater power may be required because of the heat of vaporization.

Decomposition: The temperature may reach a point at which decomposition of the fluid begins. Further increasing the temperature may accelerate decomposition to the point of danger or impracticality.

10 Troubleshooting

In the event that the user of the 6054 bath encounters difficulty in operation this section may help to find and solve the problem. Several possible problem conditions are described along with likely causes and solutions. If a problem arises please read this section carefully and attempt to understand and solve the problem. If the bath seems faulty or the problem cannot otherwise be solved, then contact the factory for assistance.

10.1 The Heater Indicator LED Stays Red But The Temperature Does Not Increase.

Here the display does not show “cut-out” nor displays an incorrect bath temperature, but the controller otherwise appears to operate normally. The problem may be either insufficient heating or no heating at all. Insufficient heating may be caused by the heater power setting being too low, especially at higher operating temperatures. Switching to a higher heater power switch setting may solve the problem. If one or more of the heaters are burned out, it also may cause this problem. If this seems the case contact the factory for assistance.

If the heater seems not to be receiving power at all, then first check the heater fuse. If the fuse is burned out, then try replacing the fuse with a new one (of the same rating) and then check to see if the bath resumes normal operation. If the fuse blows again then there may be a shorted heater. Contact the factory. If the fuse was not blown in the first place then the problem may be a faulty solid-state relay or mechanical relay. Contact the factory for assistance.

10.2 The Controller Display Flashes “CUT-OUT” And The Heater Does Not Operate.

The display will flash “CUT-OUT” alternately with the process temperature. If the process temperature displayed seems grossly in error then also consult [Section 6.8](#) after this procedure is followed. Normally the

cut-out disconnects power to the heater when the bath temperature exceeds the cut-out set-point. This will cause the temperature to drop back down to a safe value. If the cut-out mode is set to “AUTO” then the heater will switch back on when the temperature drops. If the mode is set to “RESET” then the heater will only come on again when the temperature is reduced and the cut-out is manually reset by the operator. See [Section 6.8](#). Check that the cut-out set-point is adjusted to 10 or 20°C above the desired bath operating temperature and that the cut-out mode is set as desired.

If the cut-out activates when the bath temperature is well below the cut-out set-point or the cut-out does not reset when the bath temperature drops and it is manually reset, then the cut-out circuitry may be faulty or the cut-out thermocouple sensor may be faulty or disconnected. Contact the factory for assistance.

10.3 The Display Flashes “CUT-OUT” And An Incorrect Process Temperature.

The problem may be that the controller’s voltmeter circuit is not functioning properly. This could be a problem with the memory back-up battery. If the battery power is insufficient to maintain the memory then data may become scrambled causing problems. A nearby large static discharge may also affect data in memory. The memory may be reset by holding the “SET” and “EXIT” keys down while power to the controller is switched on. The display will show “—init—” indicating the memory is being initialized. At this point, each of the controller parameters and calibration constants must be reprogrammed into memory. If this solves the problem but the same problem reoccurs then the battery should be replaced. Contact the factory. If initializing the memory does not remedy the problem then there may be a failed electronic component. Contact the factory.

10.4 The Displayed Process Temperature Is In Error And The Controller Remains In The Cooling Or Heating State At Any Set-point Value.

Possible causes of this problem may be either a faulty control probe or erroneous data in memory. The probe may be disconnected, burned out, or shorted. Check that the probe is connected properly. The probe may be checked with an ohmmeter to see if it is open or shorted. The probe is a platinum 4-wire DIN 43760 type therefore the resistance should read 0.2 to 2.0 ohms between pins 1 and 2 on the probe connector and between pins 3 and 4. The resistance should read 100 to 300 ohms between pins 1 and 4. If the probe is defective contact the factory.

If the problem is not the probe then it may be caused by erroneous data in memory. Re-initialize the memory as discussed in Section 10.3 above. If the problem remains then it may be caused by a defective electronic component. Contact the factory.

10.5 The Controller Controls Or Attempts To Control At An Inaccurate Temperature.

Here the controller operates normally except when the controller has reached stable control of the bath temperature, the temperature does not agree with that measured with the user's reference thermometer to within the specified accuracy. This problem may be caused by an actual difference in temperature between the points where the control probe and thermometer probe measure temperature or by erroneous bath calibration parameters or a damaged control probe.

Check that the bath has an adequate amount of fluid in the tank and that the pump is operating causing fluid to circulate completely. Check that the thermometer probe and control probe are both fully inserted into the bath to minimize temperature gradient errors.

Check that the calibration parameters are all correct according to the certification sheet. If not then repro-

gram the constants. It may be that the memory backup battery is weak causing errors in data as described in Section 10.3.

Check that the control probe has not been struck, bent, or damaged. If the cause of the problem remains unknown then contact the factory.

10.6 The Controller Shows That The Output Power Is Steady But The Process Temperature Is Unstable.

If the bath temperature does not achieve the expected degree of stability when measured using a thermometer, try adjusting the proportional band to a narrower width as discussed in Section 6.7.

10.7 The Controller Alternately Heats For A While Then Cools.

This is typically oscillation caused by the proportional band being too narrow. Increase the width of the proportional band until the temperature stabilizes as discussed in Section 6.7.

10.8 The Controller Erratically Heats Then Cools, Control Is Unstable.

If both the bath temperature and output power do not vary periodically but in a very erratic manner, then the problem may be excess noise in the system. Noise due to the control sensor should be less than 0.001°C. However, if the probe has been damaged or has developed an intermittent short, then this may cause erratic behavior. Check for a damaged probe or poor connection between the probe and bath. Intermittent shorts in the heater or controller electronic circuitry may also be a possible cause. Contact the factory if this seems to be the case.