

FLUKE®

— **Hart Scientific**®

5626/5628

Platinum Resistance Thermometer
User's Guide

Fluke Hart Scientific • 799 E. Utah Valley Drive • American Fork, UT 84003-9775 • USA
Phone: +1.801.763.1600 • Telefax: +1.801.763.1010 • E-mail: support@hartscientific.com

www.hartscientific.com

Subject to change without notice. • Copyright © 2005 • Printed in USA

Rev. 6B0901

Table of Contents

1	Before You Start	1
1.1	Symbols Used	1
1.2	Safety Information	2
1.2.1	Warnings	2
1.2.2	Cautions	2
1.3	Hart Scientific Authorized Service Centers	3
2	Introduction	5
2.1	General	5
2.2	Application	5
2.3	Calibration	6
2.4	Recalibration	6
3	Specifications and Warranty	7
3.1	Specifications	7
3.2	Construction	8
3.3	Electrical Circuit	8
3.4	Warranty	8
4	Installation	9
4.1	Environmental Issues	9
4.2	Mounting	9
4.3	Lead Wire Identification	9
5	PRT Care and Handling Guidelines	11
5.1	PRT Care	11
5.2	PRT Handling Guidelines	11
6	Operation	13
6.1	General	13
6.2	Comparison Calibration of Other Instruments	13
6.3	Immersion Requirements	13
6.4	Thermal EMF	14
7	Accessories	15

7.1	Case Options	15
7.2	PRT Termination	15
8	Troubleshooting	17
8.1	Troubleshooting	17

Figures

Figure 1	Hart Model 5626 and 5628 Platinum Resistance Thermometers.	5
Figure 2	Standard Dimensions.	7
Figure 3	PRT Schematic	9
Figure 4	Probe Termination Examples	15

Tables













Table 1	International Electrical Symbols	1
Table 2	Specifications.	7



1 Before You Start

1.1 Symbols Used

Table 1 lists the International Electrical Symbols. Some or all of these symbols may be used on the instrument or in this manual.

Table 1 International Electrical Symbols

Symbol	Description
	AC (Alternating Current)
	AC-DC
	Battery
	CE Complies with European Union Directives
	DC
	Double Insulated
	Electric Shock
	Fuse
	PE Ground
	Hot Surface (Burn Hazard)
	Read the User's Manual (Important Information)
	Off
	On

Symbol	Description
	Canadian Standards Association
CAT II	OVERVOLTAGE (Installation) CATEGORY II, Pollution Degree 2 per IEC1010-1 refers to the level of Impulse Withstand Voltage protection provided. Equipment of OVERVOLTAGE CATEGORY II is energy-consuming equipment to be supplied from the fixed installation. Examples include household, office, and laboratory appliances.
	C-TIC Australian EMC Mark
	The European Waste Electrical and Electronic Equipment (WEEE) Directive (2002/96/EC) mark.

1.2 Safety Information

Use this instrument only as specified in this manual. Otherwise, the protection provided by the instrument may be impaired.

The following definitions apply to the terms “Warning” and “Caution”.

“Warning” identifies conditions and actions that may pose hazards to the user.

“Caution” identifies conditions and actions that may damage the instrument being used.

1.2.1

Warnings

To avoid personal injury, follow these guidelines.

- **DO NOT** use this instrument to measure the temperature of any hazardous live component.
- **DO NOT** use this unit for any application other than calibration work.
- **DO NOT** use this unit in environments other than those listed in the user's manual.
- Use of this instrument at high temperatures for extended periods of time can cause the handle to become hot.
- Follow all safety guidelines listed in the user's manual.
- Calibration Equipment should only be used by Trained Personnel.

1.2.2

Cautions

To avoid possible damage to the instrument, follow these guidelines.

- **DO NOT** remove the label from the handle. This cautions the user concerning the delicate nature of the instrument.

- DO NOT drop or bang the probe in any way. This will cause damage to the probe internally and affect its calibration.
- Read Section 5 entitled "PRT Care and Handling Guidelines" before removing the PRT from the shipping box or case. Incorrect handling can damage the PRT and void the warranty.
- Keep the shipping container in case it is necessary to ship the PRT. Incorrect packaging of the PRT for shipment can cause irreparable damage.

1.3 Hart Scientific Authorized Service Centers

Please contact one of the following authorized Service Centers to coordinate service on your Hart product:

Hart Scientific, Inc.

799 E. Utah Valley Drive
American Fork, UT 84003-9775
USA

Phone: +1.801.763.1600
Telefax: +1.801.763.1010
E-mail: support@hartscientific.com

Fluke Nederland B.V.

Customer Support Services
Science Park Eindhoven 5108
5692 EC Son
NETHERLANDS

Phone: +31-402-675300
Telefax: +31-402-675321
E-mail: ServiceDesk@fluke.nl

Fluke Int'l Corporation

Service Center - Instrimpex
Room 2301 Sciteck Tower
22 Janguomenwai Dajie
Chao Yang District
Beijing 100004, PRC
CHINA

Phone: +86-10-6-512-3436

Telefax: +86-10-6-512-3437

E-mail: xingye.han@fluke.com.cn

Fluke South East Asia Pte Ltd.

Fluke ASEAN Regional Office

Service Center

60 Alexandra Terrace #03-16

The Comtech (Lobby D)

118502

SINGAPORE

Phone: +65 6799-5588

Telefax: +65 6799-5588

E-mail: antng@singa.fluke.com

When contacting these Service Centers for support, please have the following information available:

- Model Number
- Serial Number
- Complete description of the problem

2 Introduction

2.1 General

The Hart Platinum Resistance Thermometers (PRT) models 5626 and 5628, are designed to be the best secondary standard interpolating instrument converting temperature to resistance. The PRTs are used with a readout device to detect temperature changes or actual temperature. The PRTs cover the International Temperature Scale of 1990 (ITS-90) range from -200°C to 661°C . Two standard resistance values are available. The 5626 is 100Ω and the 5628 is 25.5Ω . Standard lengths are 12, 15, and 20 inches. Custom lengths are available on request.

The two PRTs are hand constructed at Hart Scientific by experts with years of PRT manufacturing experience. Each PRT is carefully annealed at the appropriate temperatures and precisely tested for stability. The sensing element is fabricated using high purity platinum wire wound in a strain free design on a specially designed support. The 1/4 inch O.D. Inconel 600 sheaths are sealed with a specially mixed gas and fit with a terminal box handle and strain relieved connection to the four-wire cable. Gold plated spade lugs terminate the wires.

2.2 Application

Hart 5626 and 5628 thermometers are classified as secondary standards. A secondary standard is defined in terms of transfer of the ITS-90 from a standards laboratory to a customer's laboratory. Secondary standards are



Figure 1 Hart Model 5626 and 5628 Platinum Resistance Thermometers

calibrated using a primary standard that has been calibrated in a primary calibration laboratory using known intrinsic values.

2.3 Calibration

In order for any instrument to be used as a standard it must be calibrated. The PRTs are calibrated in Hart Scientific's calibration laboratory and provided with a NIST traceable "Report of Calibration".

At the time of purchase, the 5626 and 5628 are calibrated over their entire range (-196°C to 660°C) at specified ITS-90 fixed points. Generally, a secondary PRT is calibrated by comparison method. All PRTs calibrated by Hart Scientific are calibrated using standard calibration techniques.

2.4 Recalibration

The recalibration of the 5626/5628 Secondary PRT should be scheduled according to the user's company Quality Assurance requirements. Normally, a PRT is recalibrated annually. Unless the PRT is used only over a limited range, calibration over the full range of the PRT (-196°C to 661°C) is recommended. For information on recalibrating your 5626 or 5628, contact Hart Scientific's Customer Service department for an RMA number and current pricing (see Section , Before You Start).

Depending on the user's Quality Assurance requirements, the PRT drift should be checked periodically at the Triple Point of Water (TPW). Section 8, Troubleshooting, provides information on drift with respect to mechanical shock and oxidation. If the R_{tp} cannot be restored after annealing to within calibration tolerances, a full recalibration should be scheduled.

3 Specifications and Warranty

3.1 Specifications

See Table 2 and Figure 2.

Table 2 Specifications

	5626	5628
Temperature Range	-200°C to 661°C	
R_p	100Ω ±1Ω at 0.01°C	25.5Ω ±0.5Ω at 0.01°C
Resistance RatioW(Ga)	W(302.9146K) ≥1.11807 α ≥ 0.003925	
Calibration Uncertainty (k=2)	±0.006°C at -200°C ±0.004°C at 0°C ±0.009°C at 420°C ±0.014°C at 661°C	
Short-Term Stability	±0.003°C	±0.002°C
Long-Term Drift (R_p)	≤0.03°C with 500 hours at 661°C	≤0.02°C with 500 hours at 661°C
Sheath	Inconel™ 600	
Handle Temperature Range	0°C to 80°C	
Lead Wires	4-wire Super-Flex PVC, 22 AWG	
Termination	Gold-plated spade lugs	
Size	304.8 mm x 6.35 mm dia. (12" L x 0.25") 381 mm x 6.35 mm dia. (15" L x 0.25") 508 mm x 6.35 mm dia. (20" L x 0.25")	

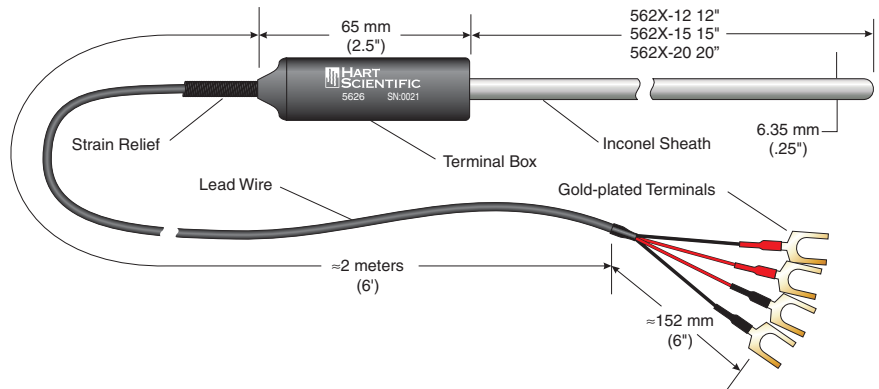

Figure 2 Standard Dimensions

3.2 Construction

The Model 5626 and 5628 PRTs cover the range from -200°C to 661°C . The sensor elements are crafted using high purity platinum wire wound in a strain free design on a specially designed support.

3.3 Electrical Circuit

The PRTs are provided with a terminal box handle. The two meter cable has four Super-Flex wires enclosed in a PVC jacket with a stainless steel spring strain relief. Gold plated spade lugs terminate the wires.

3.4 Warranty

Hart Scientific, Inc. (Hart) warrants this product to be free from defects in material and workmanship under normal use and service for a period as stated in our current product catalog from the date of shipment. This warranty extends only to the original purchaser and shall not apply to any product which, in Hart's sole opinion, has been subject to misuse, alteration, abuse or abnormal conditions of operation or handling.

Software is warranted to operate in accordance with its programmed instructions on appropriate Hart products. It is not warranted to be error free.

Hart's obligation under this warranty is limited to repair or replacement of a product which is returned to Hart within the warranty period and is determined, upon examination by Hart, to be defective. If Hart determines that the defect or malfunction has been caused by misuse, alteration, abuse or abnormal conditions or operation or handling, Hart will repair the product and bill the purchaser for the reasonable cost of repair.

To exercise this warranty, the purchaser must forward the product after calling or writing an Authorized Hart Scientific Service Center (see Section 1.3 on page 3) for authorization. The Service Center assumes NO risk for in-transit damage.

THE FOREGOING WARRANTY IS PURCHASER'S SOLE AND EXCLUSIVE REMEDY AND IS IN LIEU OF ALL OTHER WARRANTIES, EXPRESS OR IMPLIED, INCLUDING BUT NOT LIMITED TO ANY IMPLIED WARRANTY OR MERCHANTABILITY, OR FITNESS FOR ANY PARTICULAR PURPOSE OR USE. HART SHALL NOT BE LIABLE FOR ANY SPECIAL, INDIRECT, INCIDENTAL, OR CONSEQUENTIAL DAMAGES OR LOSS WHETHER IN CONTRACT, TORT, OR OTHERWISE.

4 Installation

4.1 Environmental Issues

Ideally, temperature calibration equipment should be used in a calibration laboratory or other facility specifically designed for this purpose. Environmental requirements include:

- Stable temperature and relative humidity <80%
- Clean, draft-free area
- Low noise level: low radio frequency, magnetic or electrical interference
- Low vibration levels

4.2 Mounting

Most often temperature standards, primary and secondary, are used to calibrate other temperature-sensitive equipment. The PRT must be mounted carefully to avoid any damage to the sheath or sensor. If the fluid bath used does not have a lid designed for PRT insertion, clamps should be used to ensure the handle and cable are not immersed. **Do not screw the clamps too tight. Over tightening will damage the sheath.** If metal comparison blocks are used in the bath, maintain a close fit between the thermometer sheath and the well in the comparison block. However, allow for the thermal expansion of the thermometer sheath when determining block well tolerances.

4.3 Lead Wire Identification

The 5626 and 5628 PRTs are equipped with a four-wire cable. The same circuit schematic applies to both PRTs (see Figure 3). Four lead wires are used to cancel lead wire resistance. For best results, the readout device should be equipped to handle four-terminal resistors.



Figure 3 PRT Schematic

The lead wires are four different colors. Lead wire pairs attached to each end of the sensor are identified by red and black heat shrink tubing.

5 PRT Care and Handling Guidelines

5.1 PRT Care



CAUTION: READ THIS SECTION BEFORE REMOVING THE PRT FROM THE SHIPPING BOX OR CASE

The 5626 and 5628 Platinum Resistance Thermometers (PRTs) are delicate instruments. Care must be taken in handling the PRTs to maintain calibration accuracy. The stress free design of the PRT sensor reduces the effects of mechanical shock. In addition, contamination problems of the sensor at high temperature have been eliminated. However, care should still be used when handling the PRT even though the Inconel sheath is durable and provides good protection for the sensor. Correct handling of the PRT will prolong the life expectancy. When not in use, the PRT should be stored in the protective case provided by Hart.



Note: The PRT sheath changes color after use at high temperatures. The PRT may arrive with a brown tint to the sheath due to calibration at high temperatures.

The handle is not designed to be immersed. The temperature limits of the handle are: 0°C to 80°C. Temperatures outside these limits can damage the sealed portion of the handle and the connectors.

5.2 PRT Handling Guidelines

- **DO** anneal the thermometer after shipment. Shipping the thermometer can cause mechanical shocks that effect the accuracy of the thermometer. Therefore, if possible, we advise that the thermometer be annealed before use. The thermometer should be annealed at 500°C overnight or 660°C for four (4) hours.
- **DO** keep the thermometer as clean as possible. Always remove any fluid from the sheath immediately after taking the thermometer from a bath.
- **DO** immerse the thermometer in the appropriate liquid for the temperature range. If a dry block is used, the well diameter should allow the PRT to comfortably slip in and out without excess movement. For best results, immerse the thermometer as deep as possible to avoid "stem effect" (the temperature error caused by the conduction of heat away from the sensor). Do not submerge the handles.

- **DO** allow sufficient time for the thermometer to stabilize before making measurements. This allows for the best accuracy.
- **DO** use the correct drive current with the thermometer to prevent error in temperature or resistance. Hart Scientific recommends 1 mA.
- **DO** anneal the thermometer at 600 to 661°C for 12 hours if it becomes oxidized.
- **DO** use the protective shipping box or case provided or other protection when the thermometer is not in use.
- **DO NOT** subject the thermometer to any physical shock or vibration.
- **DO NOT** use pliers or other devices to squeeze the sheath. This action can permanently damage the PRT.
- **DO NOT** subject the thermometer to temperatures above the highest specified operating temperature.
- **DO NOT** expose the thermometer's handle or cables to extreme temperatures. The temperature limits of the handle are: 0°C to 80°C
- **DO NOT** submerge the handle or cable in liquids.
- **DO NOT** screw a clamp down so tight that it dents the sheath. This can permanently damage the PRT.

6 Operation

6.1 General

For best results, be familiar with the operation of the heat source and the read-out instrument. Be sure to follow the manufacturer's instructions for the read-out instrument and the heat source.

6.2 Comparison Calibration of Other Instruments

The uniformity and stability of the heat source and the degree of accuracy required determine the number of temperature measurements necessary. However, to follow "good" practice procedures, always measure the triple point of water (R_{tp}) after each temperature measurement. The following equation provides the most accurate measurement of the ratio:

$$W_t = \frac{R_t}{R_{tp}}$$

All PRTs experience errors caused by self-heating of the element. Self-heating is a combination of two factors, heat dissipation and heat sink. Self-heating error can be reduced to have a negligible effect if the PRT is used with the same excitation current and medium in which it was calibrated.

6.3 Immersion Requirements

Stem effect can cause measurement errors for any thermometer not immersed in the fluid at least 152 mm (6 inches). This error is due to heat lost or gained by the sensing element through the thermometer stem. In addition, heat losses occur due to radiation losses from the sensing element to the housing.

The immersion depth for standards is dependent on several factors including accuracy requirements and type of liquid. Therefore, we recommend a 152 mm (6 inches) minimum immersion depth. However, remember the handle limitations. The handle is not designed to be immersed. The temperature limits of the handle are 0°C to 80°C. Temperatures outside these limits can damage the handle. Convection of heat from the heat source must be kept within the handle limits.

The exact immersion depth required can be determined by performing a gradient test taking measurements approximately every 1.27 cm (.5 inches) until there is a significant difference in readings. Allow the thermometer to stabilize at each new depth. Plot the results to see the stem effect.

6.4 Thermal EMF

Two factors contribute to thermal EMF, chemical consistency and physical consistency. Variations in chemical structure due to impurities can contribute to thermal EMF. Also discrepancies in crystal structure can contribute to thermal EMF. These factors are minimized by annealing the full length of wire before construction of the PRT.

Likewise, connection to extension lead wires and readout instruments can be a source of thermal EMF. The thermal EMF is caused by a difference in temperature between two connections. If the two connections are the same temperature, there will be little or no thermal EMF effects. However, if there is a substantial temperature difference between connections, the thermal EMF effects will be significant. Therefore, cover or insulate any exposed bridge or galvanometer terminals to lessen the source of error. The effects of thermal EMF can be canceled by using an AC bridge or a DC bridge with reversible current.

7 Accessories

7.1 Case Options

The 5626/5628 PRT comes in a rigid case appropriate for the length of the probe.

- Model Number 2601 PRT Protective Case for 5626-12 and 5628-12 PRT
- Model Number 2609 PRT Protective Case for 5626-15, 5628-15, 5626-20, and 5628-20 PRT

7.2 PRT Termination

The 5626/5628 PRT can be terminated in three ways (Figure 4) depending on the user's requirements:

- Gold Plated Spade Lug
- Bare Wire
- 5-Pin Din Connector

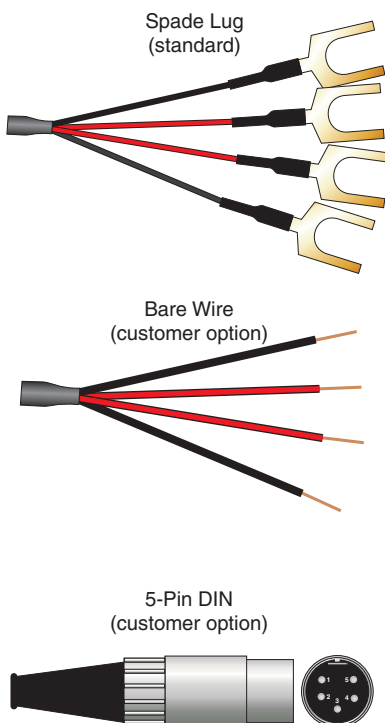

Figure 4 Probe Termination Examples

8 Troubleshooting

8.1 Troubleshooting

In the event that the probe appears to function abnormally, this section may be of use in solving the problem. Several possible problem conditions are described along with likely causes and solutions. If a problem arises, please read this section carefully and attempt to understand and solve the problem. If the probe seems faulty or the problem cannot otherwise be solved, contact an Authorized Hart Scientific Service Center (see Section 1.3) for assistance. Be sure to have the model number and serial number of your probe available.

Problem	Causes and Solutions
Data changes greater than 0.1°C are observed	<ul style="list-style-type: none"> Mechanical shock can cause temperature errors as great as 0.5°C. If this is observed, first measure and record the R_{tp}. Next anneal the PRT at 660°C overnight. Measure the R_{tp} again. The annealing should decrease the R_{tp}. If the R_{tp} is stable, recalibrate the PRT.
Data changes less than 0.1°C	<ul style="list-style-type: none"> Slight mechanical shock can cause temperature errors less than 0.1°C. If this is observed, first measure and record the R_{tp}. Next anneal the PRT at 660°C overnight. Measure the R_{tp} again. The annealing should decrease the R_{tp}. Repeat the annealing, R_{tp} measurement cycle several times. When the R_{tp} is stable, recalibrate the PRT. If the R_{tp} does not stabilize, contact an Authorized Hart Scientific Service Center (see Section 1.3). Oxidation of the platinum sensor may occur after prolonged use between 200 – 450°C. This oxidation will demonstrate itself by an increase in R_{tp} of less than 0.1°C. To reduce the effects of oxidation, anneal the PRT at 600 – 661°C overnight (12 hr.). Measure the R_{tp} again. Repeat the annealing, R_{tp} measurement cycle several times. This annealing process should return R_{tp} to within calibration tolerances. If the R_{tp} is within calibration tolerance, the PRT is usable. If the R_{tp} is not within calibration tolerance, but it is stable, recalibrate the PRT.
Data unstable	<ul style="list-style-type: none"> If the data is unstable at the Triple Point of Water (TPW), check the connector. If the connector is correct, contact an Authorized Hart Scientific Service Center (see Section 1.3). The PRT may be damaged and need repair. If the data is unstable at high temperatures, it may be due to electrical noise in the system. Reduce the temperature and observe the data. If it is stable, electrical noise is interfering with the measurements at high temperatures. Check the grounding of the readout device and the heat source. A faulty ground on either device could interfere with high temperature measurements. A ground wire attached to the metal sheath of the PRT may help to reduce electrical noise interference.

Problem	Causes and Solutions
Temperature readout different than expected, e.g. the heat source is set at 300°C, the PRT measures 275°C.	<ul style="list-style-type: none">• Measure the PRT resistance at TPW.• If the resistance of the PRT is less than the rated resistance, e.g. 70 Ω for the 5626, there may be a short in the sensor. Contact an Authorized Hart Scientific Service Center (see Section 1.3).• If the resistance of the PRT is only a few ohms, there may be a short in the four lead-wires. Contact an Authorized Hart Scientific Service Center (see Section 1.3).• If the PRT is open, the resistance will be "Out of Limits" or in the kilo-ohm or mega-ohm range. Contact an Authorized Hart Scientific Service Center (see Section 1.3).